

Multipath TCP

Olivier Bonaventure

<http://inl.info.ucl.ac.be>

Thanks to Sébastien Barré, Christoph Paasch, Grégory Detal,
Mark Handley, Costin Raiciu, Alan Ford, Micchio Honda, Fabien
Duchene and many others

November 2012



Agenda

The motivations for Multipath TCP

- The changing Internet
- The Multipath TCP Protocol
- Multipath TCP use cases

The origins of TCP



Source : <http://spectrum.ieee.org/computing/software/the-strange-birth-and-long-life-of-unix>

The Unix pipe model

```
Terminal — bash — 49x7
Last login: Tue Nov 13 10:07:47 on ttys006
You have new mail.
mbpobo:~ obo$ echo "1234 abbsbbbs" | wc -c
      14
mbpobo:~ obo$
```

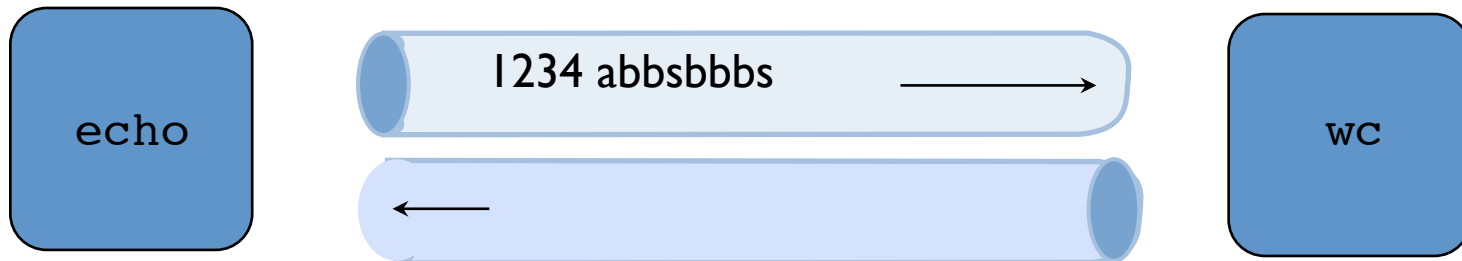

The TCP bytestream model

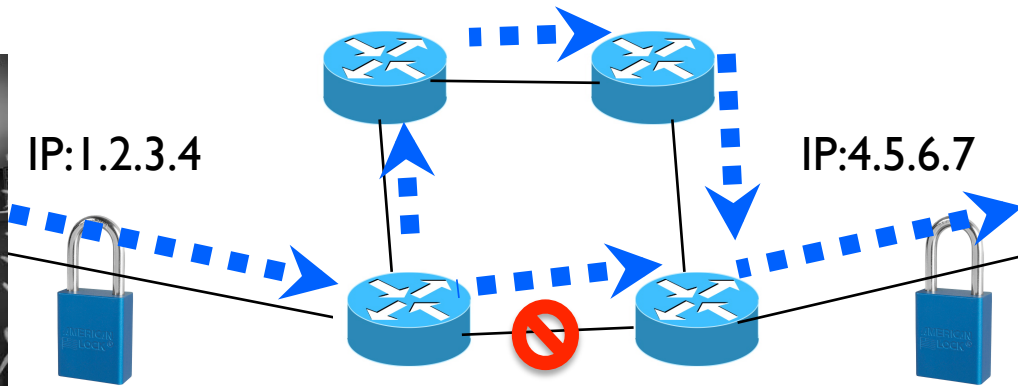
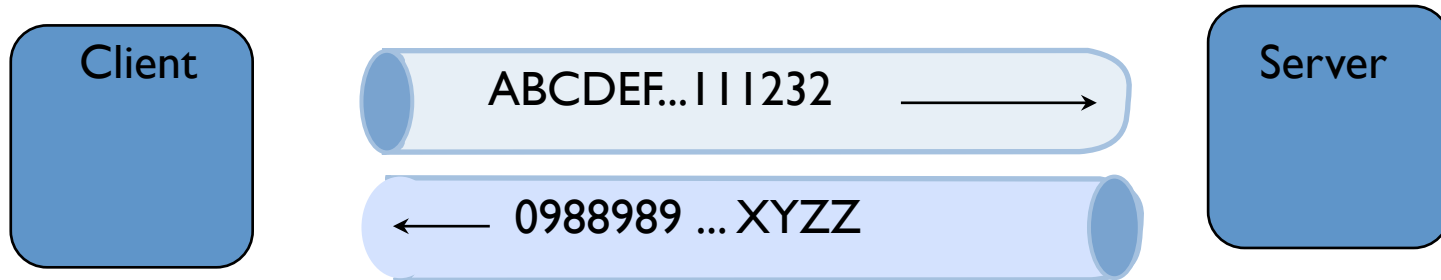

Endhosts have evolved



Mobile devices have multiple wireless interfaces

User expectations

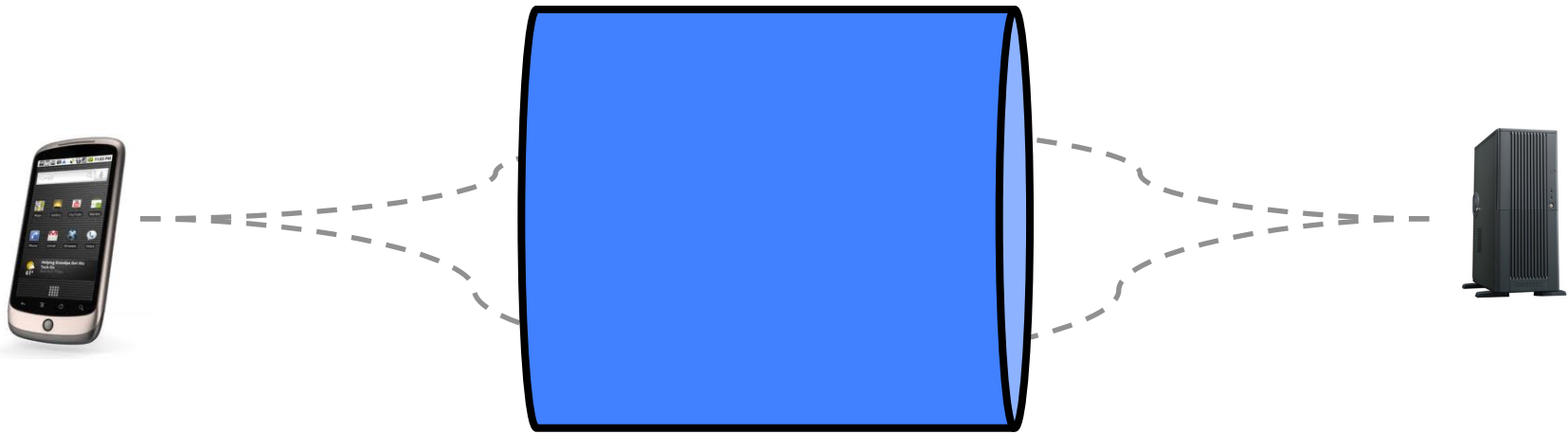

What technology provides

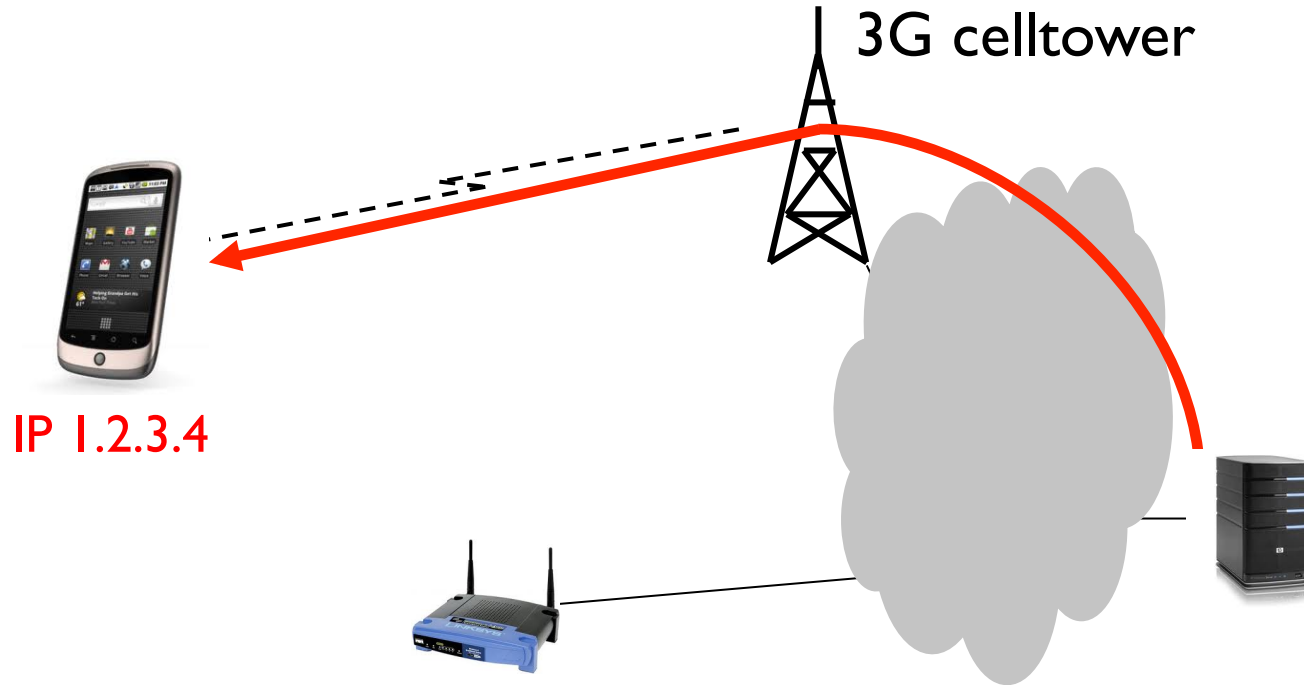

What technology provides

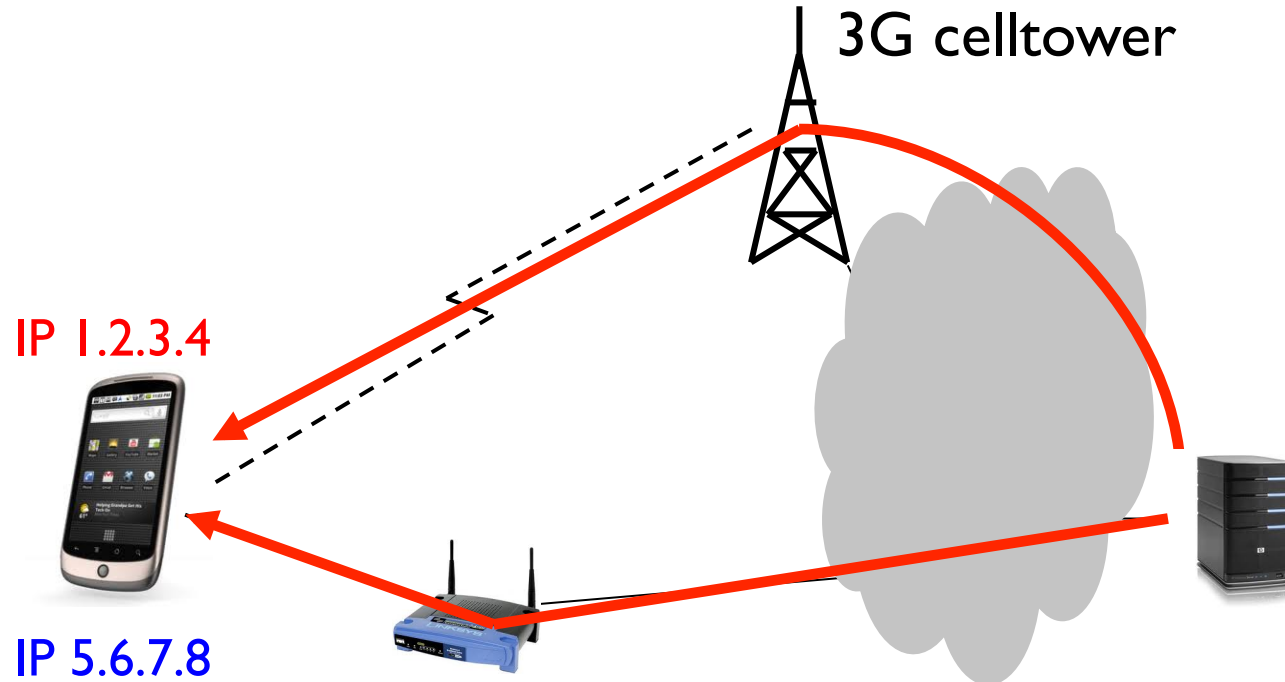

What technology provides

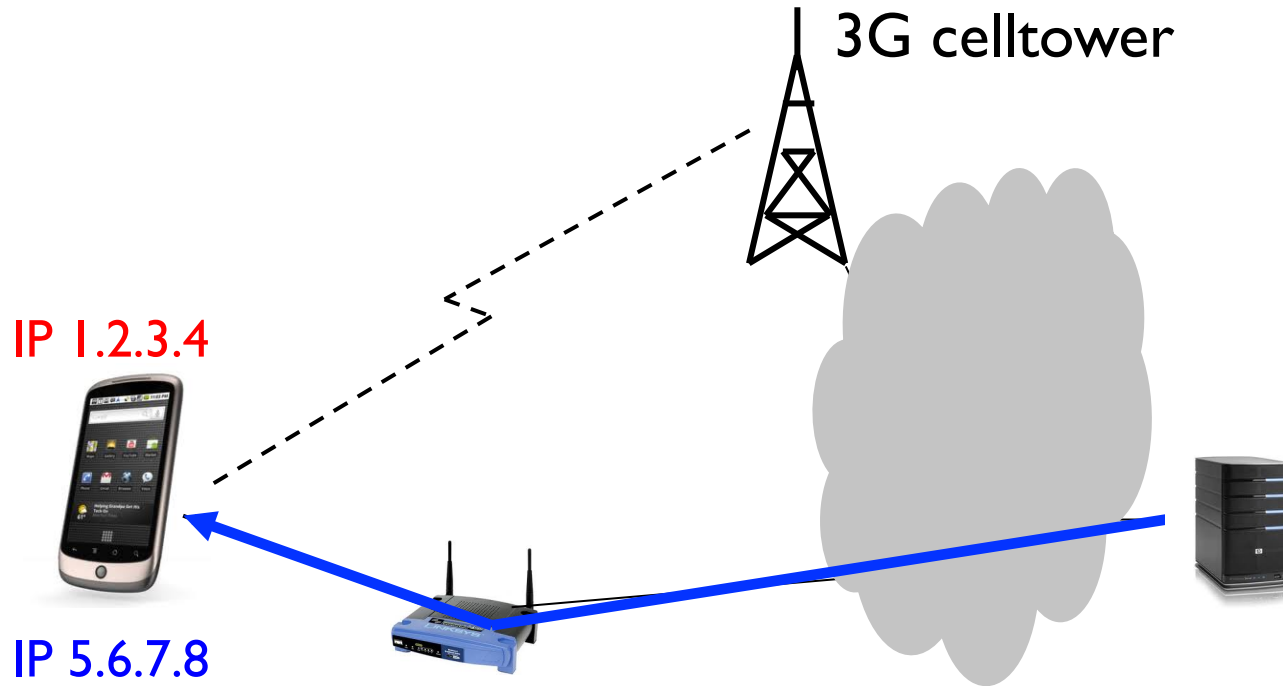

When IP addresses change TCP connections have to be re-established !

Equal Cost Multipath



ECMP implementation

Packet arrival :

$$\text{Hash}(\text{IP}_{\text{src}}, \text{IP}_{\text{dst}}, \text{Prot}, \text{Port}_{\text{src}}, \text{Port}_{\text{dst}}) \bmod \# \text{oif}$$

Packets from one TCP connection follow same path

Different connections follow different paths

How prevalent is ECMP ?

- Analysis of ISP network topologies

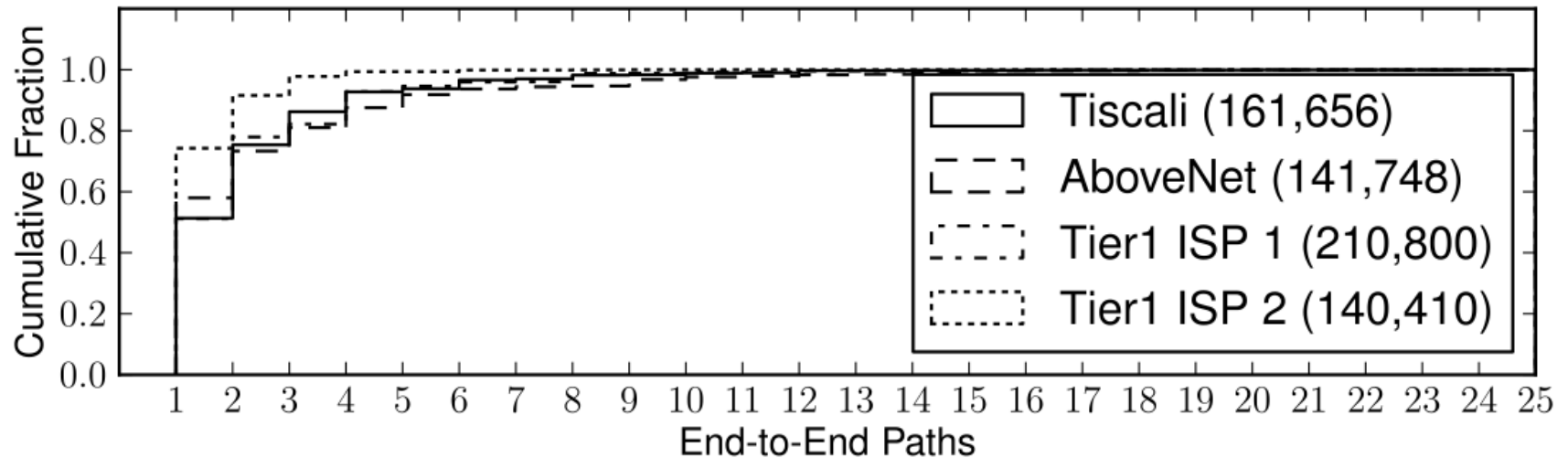

Datacenters



ECMP in datacenters

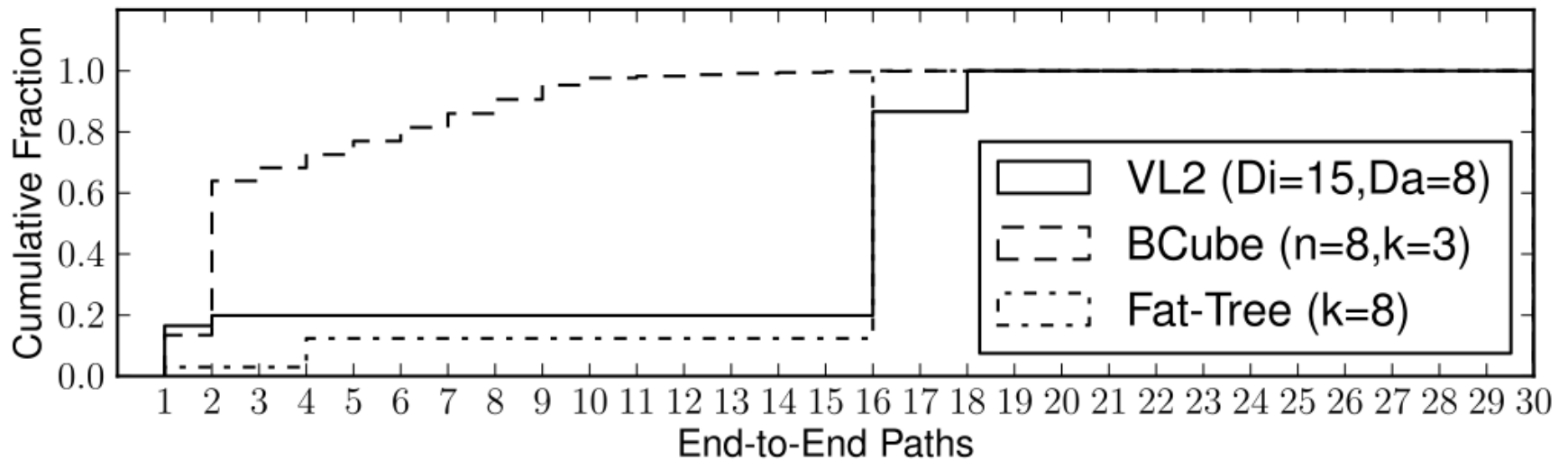

IPv4 and IPv6 paths are not always congruent

IP6=2a00:cafe::1

IP=3.4.5.6

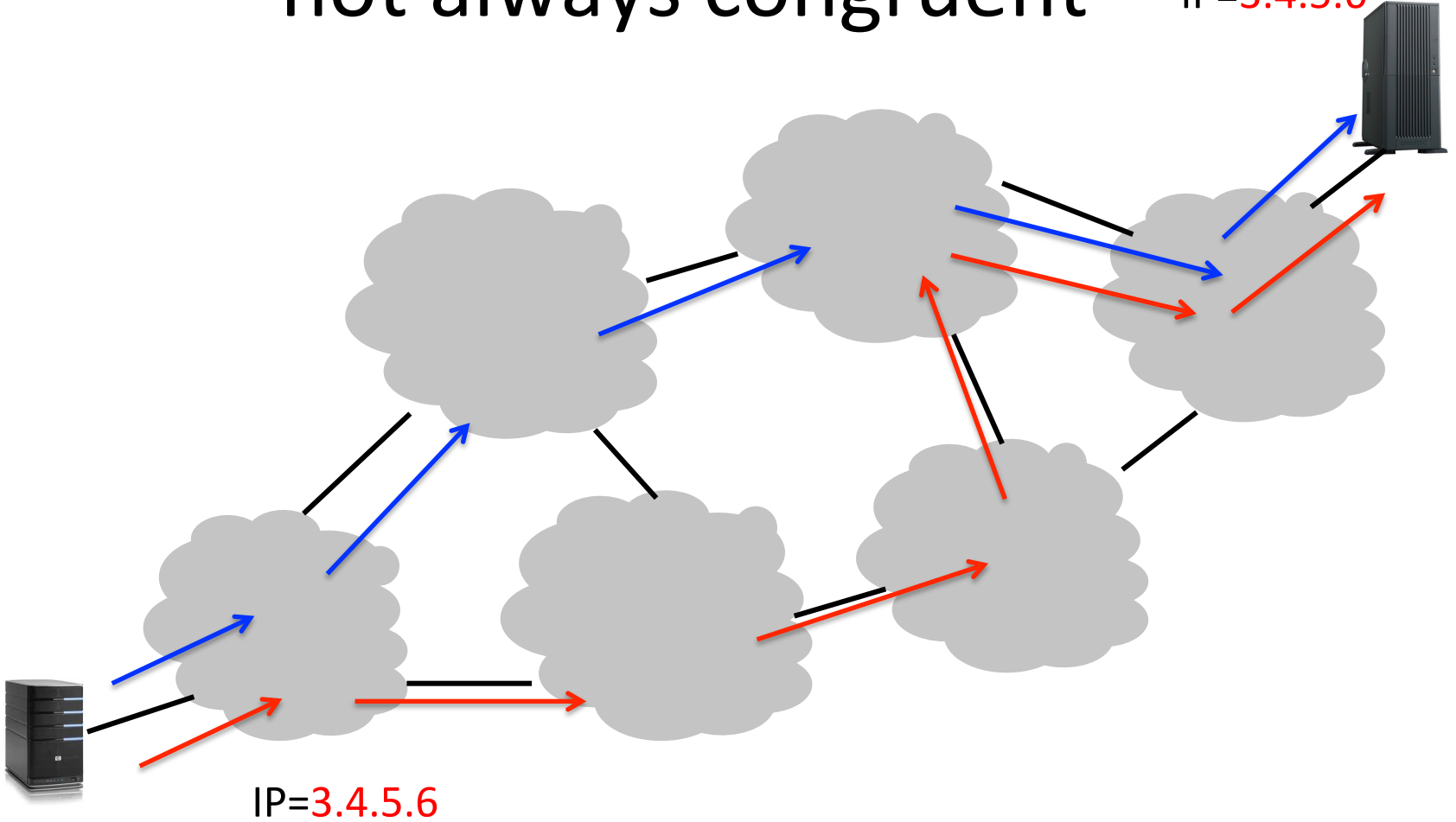

IP=3.4.5.6

IP6=2a00:1450:400c:c05::69

IPv4 and IPv6 performance may differ

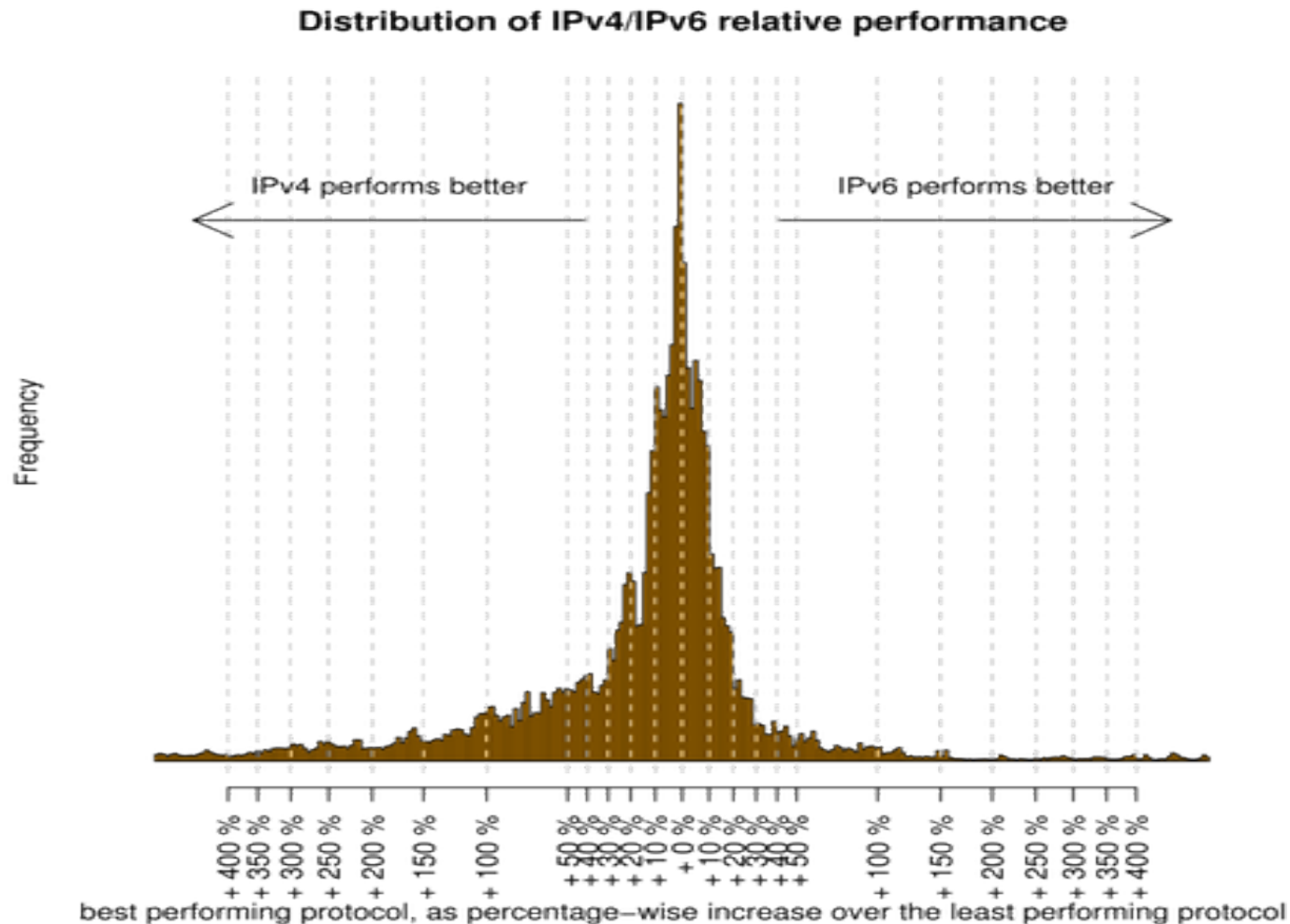

E. Aben, *Measuring World IPv6 Day - Comparing IPv4 and IPv6 Performance*,
<https://labs.ripe.net/Members/emileaben/measuring-world-ipv6-day-comparing-ipv4-and-ipv6-performance>

IPv4 versus IPv6 performance

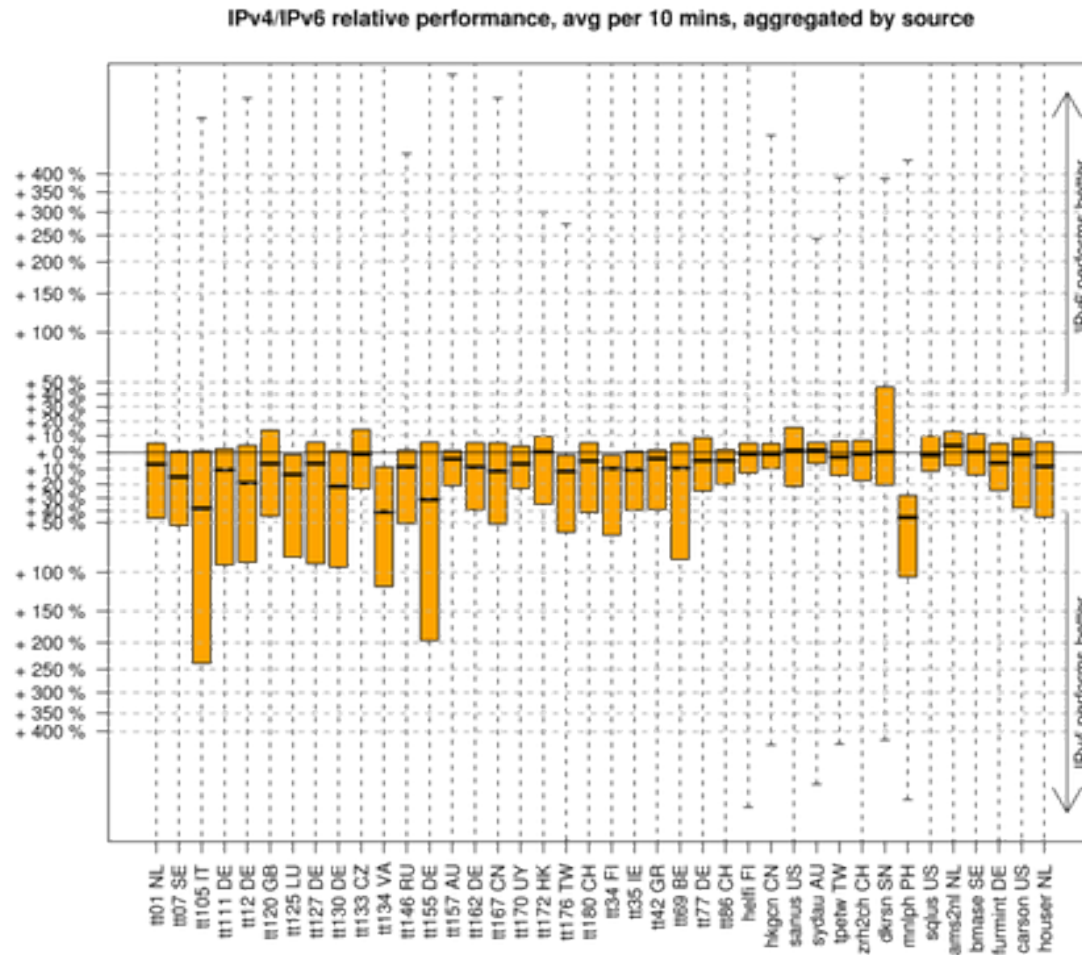

E. Aben, *Measuring World IPv6 Day - Comparing IPv4 and IPv6 Performance*,

<https://labs.ripe.net/Members/emileaben/measuring-world-ipv6-day-comparing-ipv4-and-ipv6-performance>

Agenda

- The motivations for Multipath TCP

The changing Internet

- The Multipath TCP Protocol
- Multipath TCP use cases

The Internet architecture that we explain to our students

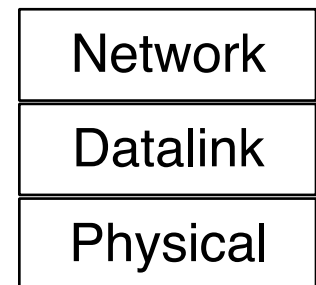
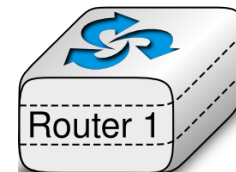
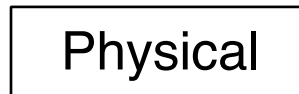
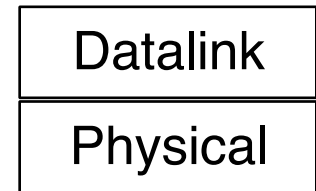
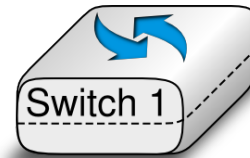
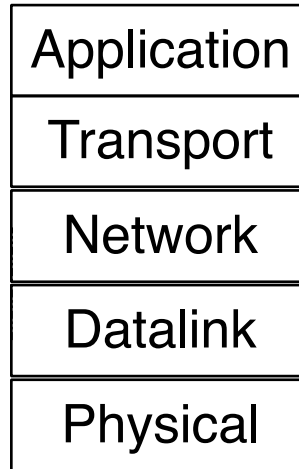

A typical "academic" network

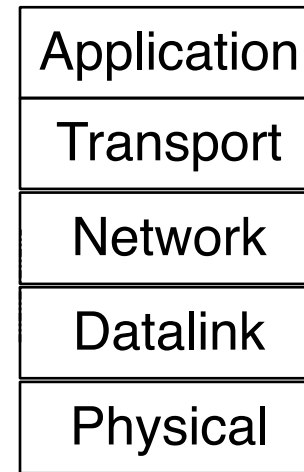
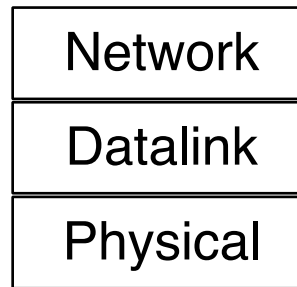
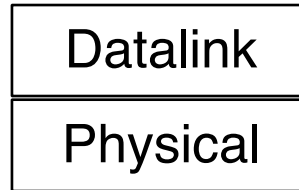
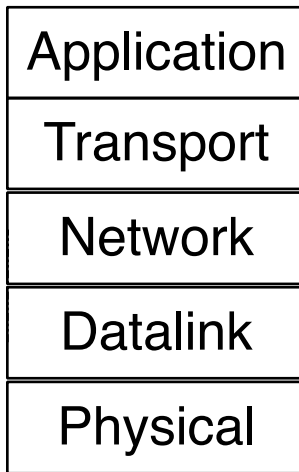
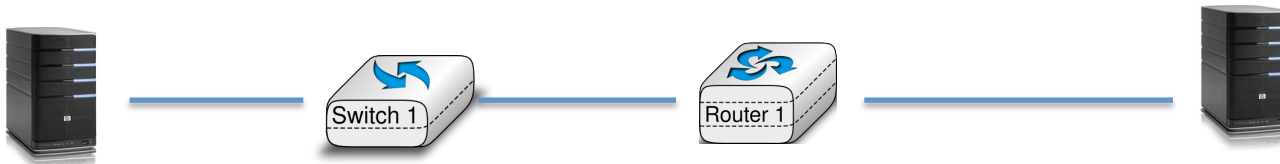

The end-to-end principle

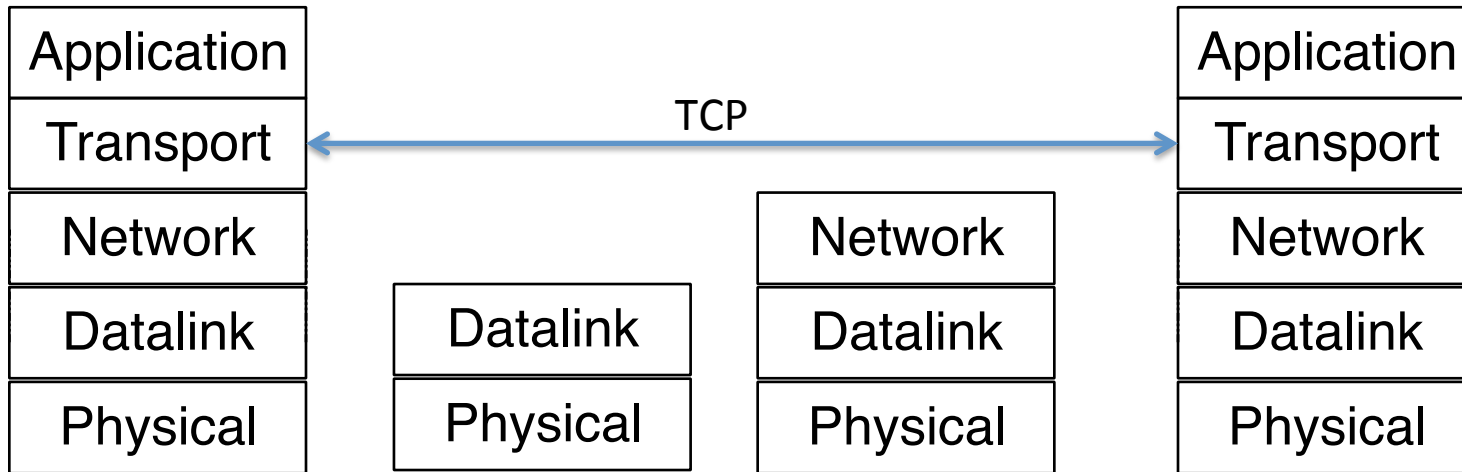
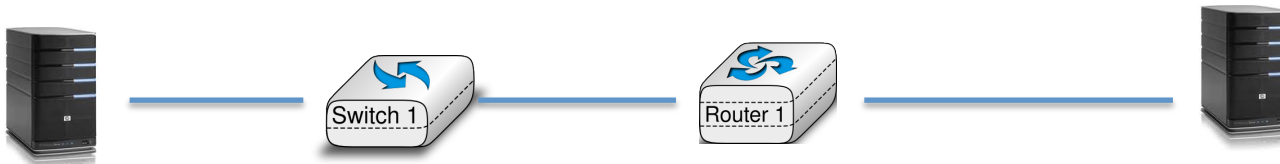

In reality

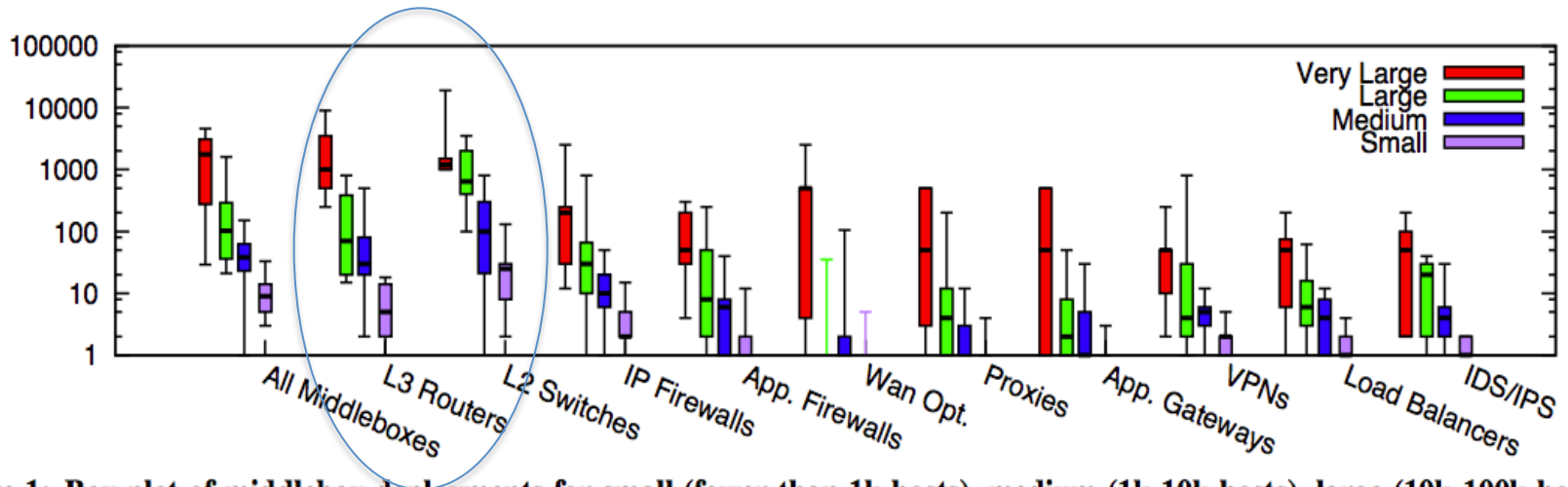

Figure 1: Box plot of middlebox deployments for small (fewer than 1k hosts), medium (1k-10k hosts), large (10k-100k hosts), and very large (more than 100k hosts) enterprise networks. Y-axis is in log scale.

- almost as many middleboxes as routers
- various types of middleboxes are deployed

Sherry, Justine, et al. "Making middleboxes someone else's problem: Network processing as a cloud service." Proceedings of the ACM SIGCOMM 2012 conference. ACM, 2012.

A middlebox zoo



Web Security Appliance

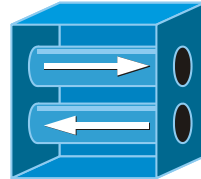

VPN Concentrator

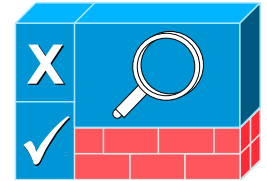

NAC Appliance

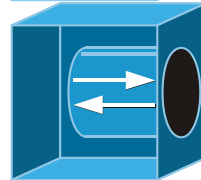

SSL Terminator

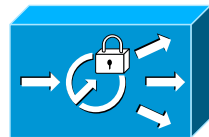

ACE XML Gateway



PIX Firewall Right and Left

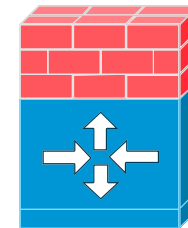

Cisco IOS Firewall



IP Telephony Router

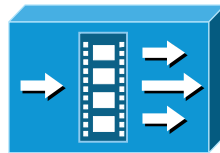

Streamer



Voice Gateway

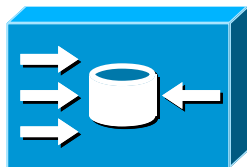

Content Engine



NAT

<http://www.cisco.com/web/about/ac50/ac47/2.html>

How to model those middleboxes ?

- In the official architecture, they do not exist
- In reality...

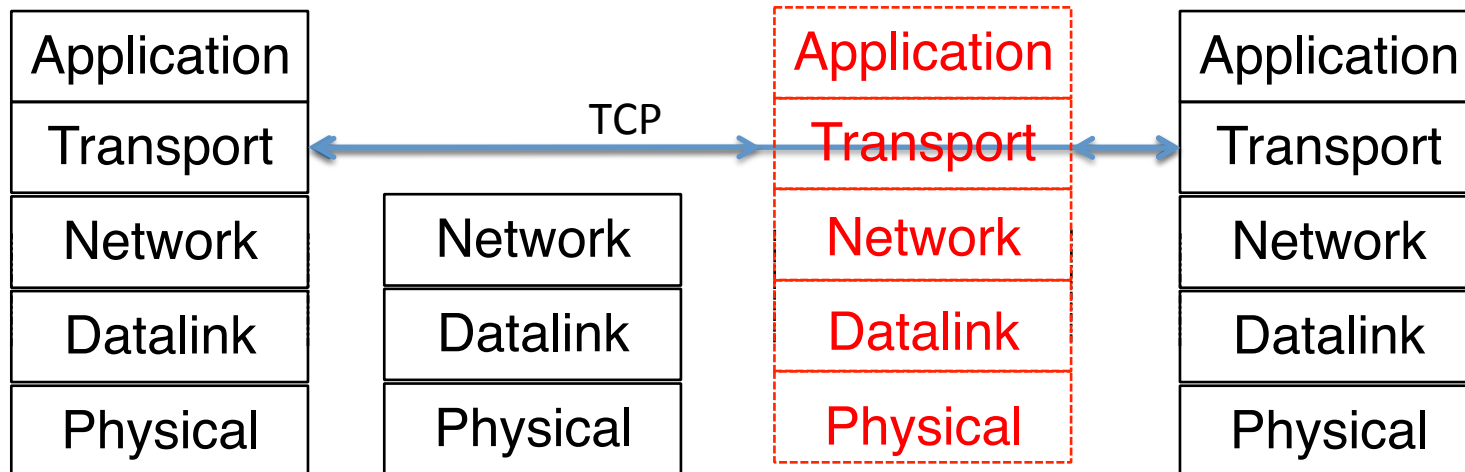
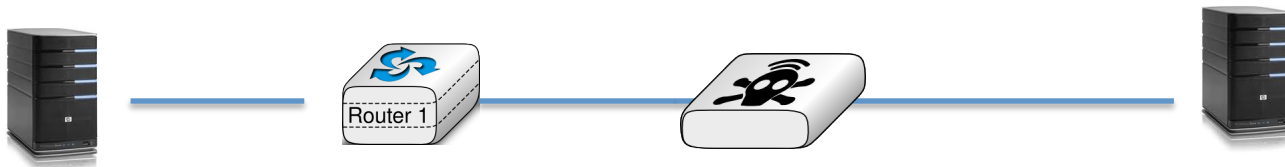

TCP segments processed by a router

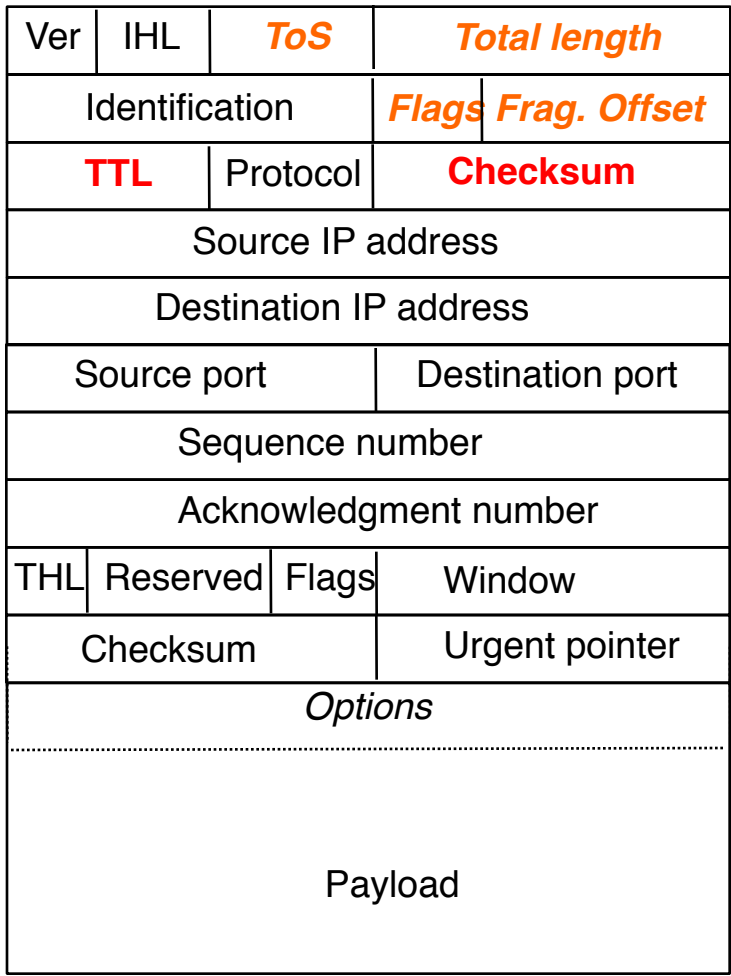
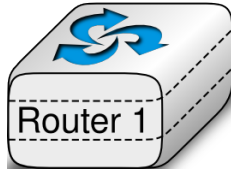
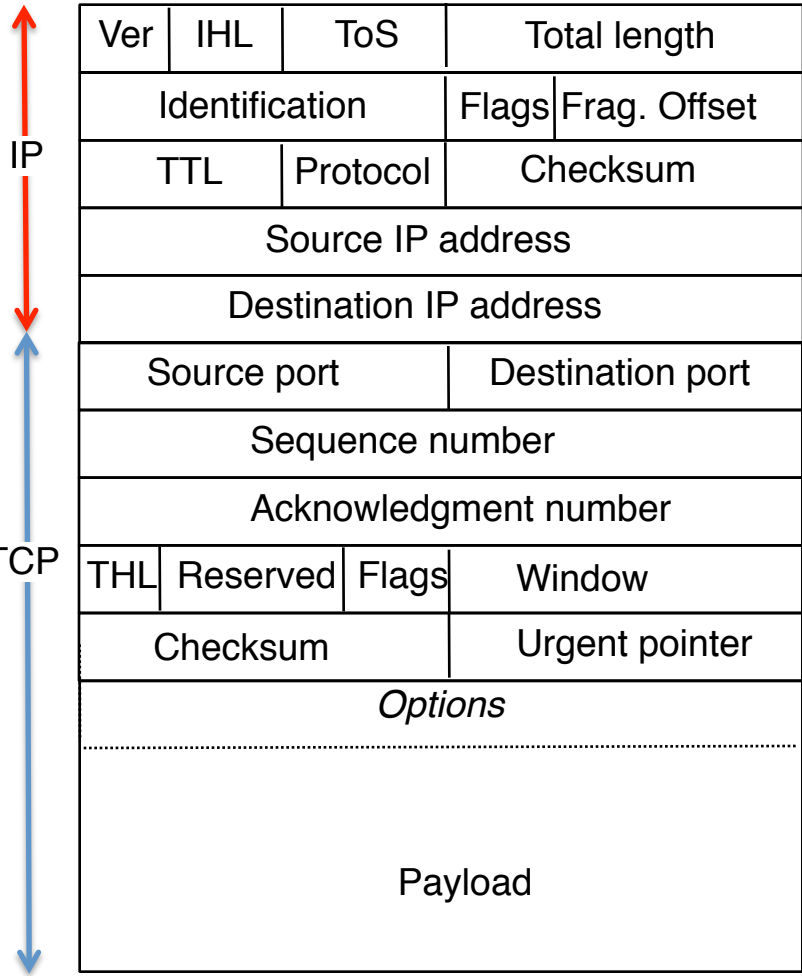

TCP segments processed by a NAT

Ver	IHL	ToS	Total length	
Identification		Flags	Frag. Offset	
TTL	Protocol	Checksum		
Source IP address				
Destination IP address				
Source port		Destination port		
Sequence number				
Acknowledgment number				
THL	Reserved	Flags	Window	
Checksum		Urgent pointer		
<i>Options</i>				
Payload				

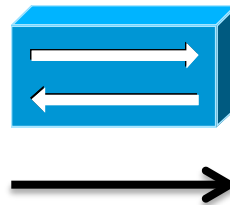

Ver	IHL	<i>ToS</i>	<i>Total length</i>	
Identification		<i>Flags</i>	<i>Frag. Offset</i>	
TTL	Protocol	Checksum		
Source IP address				
Destination IP address				
Source port		Destination port		
Sequence number				
Acknowledgment number				
THL	Reserved	Flags	Window	
Checksum		Urgent pointer		
<i>Options</i>				
Payload				

TCP segments processed by a NAT (2)

- active mode ftp behind a NAT

220 ProFTPD 1.3.3d Server (BELNET FTPD Server) [193.190.67.15]

ftp_login: user ``<null>`' pass ``<null>`' host `ftp.belnet.be'

Name (ftp.belnet.be:obo): anonymous

---> USER anonymous

331 Anonymous login ok, send your complete email address as your password

Password:

---> PASS XXXX

---> **PORT 192,168,0,7,195,120**

200 PORT command successful

---> LIST

150 Opening ASCII mode data connection for file list

lrw-r--r-- 1 ftp ftp 6 Jun 1 2011 pub -> mirror

226 Transfer complete

TCP segments processed by an ALG running on a NAT

Ver	IHL	ToS	Total length	
Identification		Flags	Frag. Offset	
TTL	Protocol	Checksum		
Source IP address				
Destination IP address				
Source port		Destination port		
Sequence number				
Acknowledgment number				
THL	Reserved	Flags	Window	
Checksum		Urgent pointer		
<i>Options</i>				
.....				
Payload				

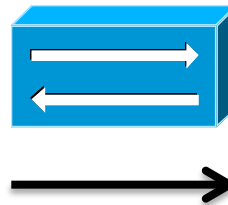

Ver	IHL	<i>ToS</i>	<i>Total length</i>	
Identification		<i>Flags</i>	<i>Frag. Offset</i>	
TTL	Protocol	Checksum		
Source IP address				
Destination IP address				
Source port		Destination port		
Sequence number				
Acknowledgment number				
THL	Reserved	Flags	Window	
Checksum		Urgent pointer		
<i>Options</i>				
.....				
Payload				

How transparent is the Internet ?

- 25th September 2010 to 30th April 2011
- 142 access networks
- 24 countries
- Sent specific TCP segments from client to a server in Japan

Table 2: Experiment Venues

Country	Home	Hotspot	Cellular	Univ	Ent	Hosting	Total
Australia	0	2	0	0	0	1	3
Austria	0	0	0	0	1	0	1
Belgium	4	0	0	1	0	0	5
Canada	1	0	1	0	1	0	3
Chile	0	0	0	0	1	0	1
China	0	7	0	0	0	0	7
Czech	0	2	0	0	0	0	2
Denmark	0	2	0	0	0	0	2
Finland	1	0	0	3	2	0	6
Germany	3	1	3	4	1	0	12
Greece	2	0	1	0	0	0	3
Indonesia	0	0	0	3	0	0	3
Ireland	0	0	0	0	0	1	1
Italy	1	0	0	0	1	0	2
Japan	19	10	7	3	2	0	41
Romania	1	0	0	0	0	0	1
Russia	0	1	0	0	0	0	1
Spain	0	1	0	1	0	0	2
Sweden	1	0	0	0	0	0	1
Switzerland	2	0	0	0	0	0	2
Thailand	0	0	0	0	2	0	2
U.K.	10	4	4	2	1	1	22
U.S.	3	4	4	0	4	2	17
Vietnam	1	0	0	0	1	0	2
Total	49	34	20	17	17	5	142

How to extend TCP ?

RFC1323

- Large window extension
 - supports >64KBytes windows by shifting window field in TCP segment header

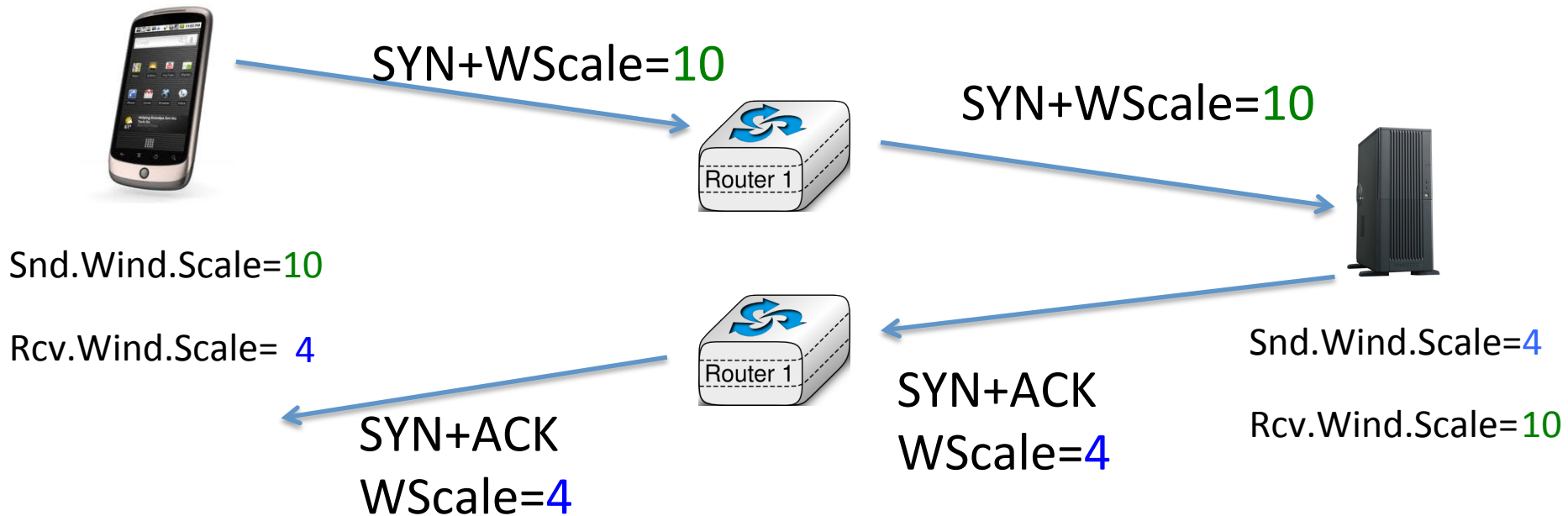

How to extend TCP ?

RFC1323

- What happens with middleboxes ?

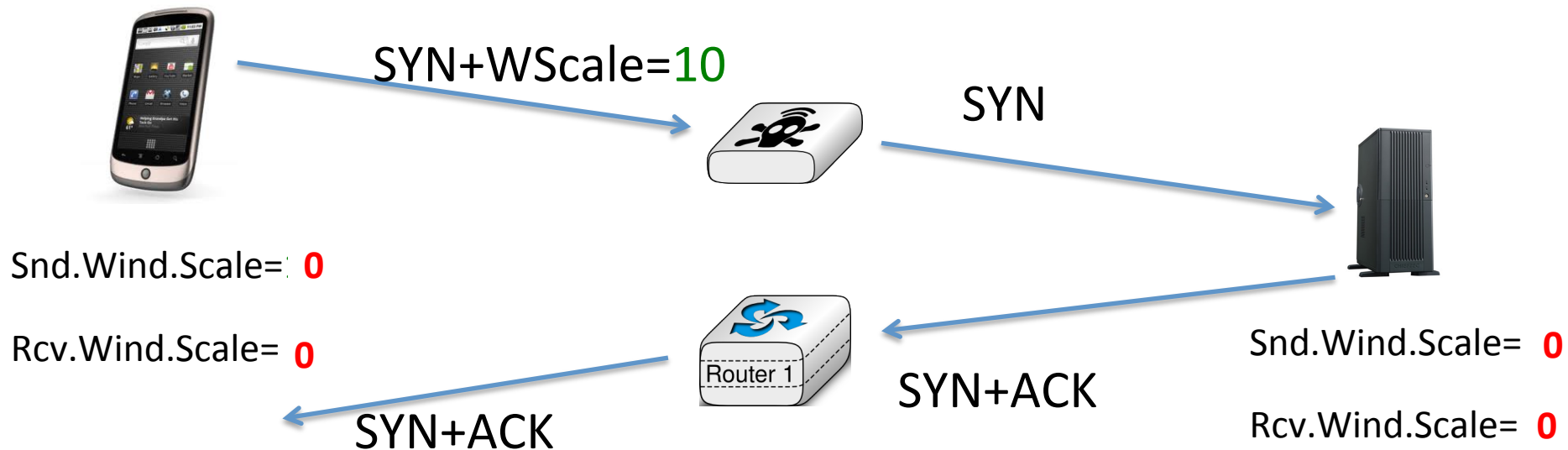

How to extend TCP ?

RFC1323

- What happens with middleboxes ?

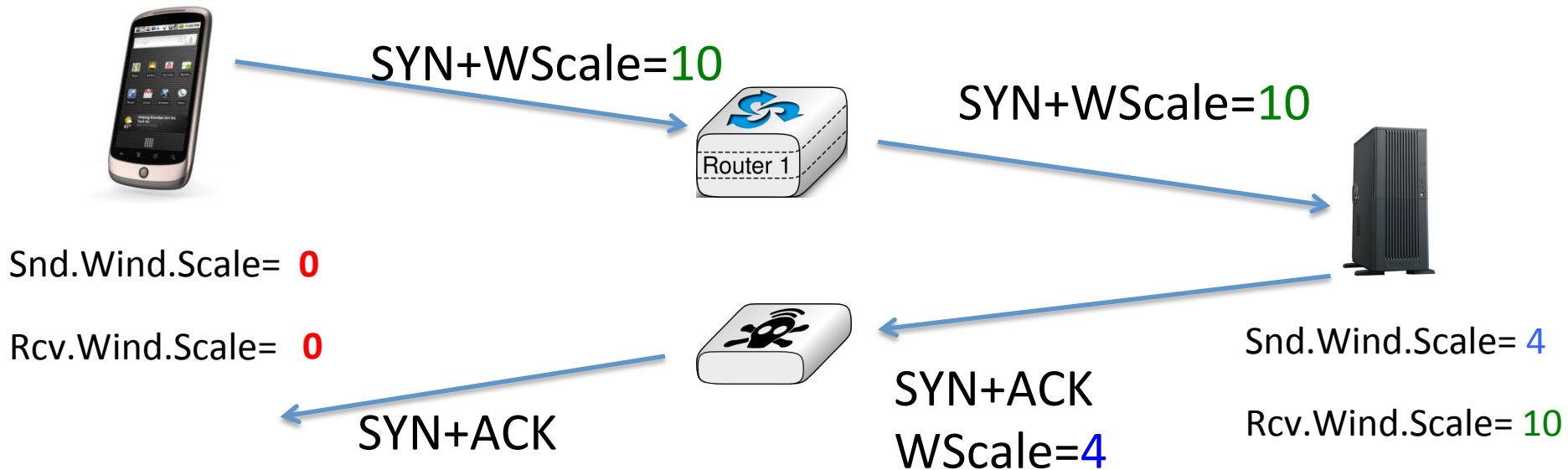

End-to-end transparency today

Ver	IHL	ToS	Total length
Identification		Offset	
TTL			
Protocol			
Source IP address			
Destination IP address			
Source port		Destination port	
Sequence number			
Acknowledgment number			
THL	Reserved	Flags	Window
Checksum		Urgent pointer	
Options			
Payload			

Middleboxes don't change the Protocol field, but many discard packets with an unknown Protocol field



Ver	IHL	<i>ToS</i>	<i>Total length</i>
<i>Identification</i>		<i>Flags</i>	<i>Frag. Offset</i>
<i>TTL</i>	Protocol	<i>Checksum</i>	
<i>Source IP address</i>			
<i>Destination IP address</i>			
<i>Source port</i>		<i>Destination port</i>	
<i>Sequence number</i>			
<i>Acknowledgment number</i>			
<i>THL</i>	<i>Reserved</i>	<i>Flags</i>	<i>Window</i>
<i>Checksum</i>		<i>Urgent pointer</i>	
<i>Options</i>			
<i>Payload</i>			

Agenda

- The motivations for Multipath TCP
- The changing Internet

The Multipath TCP Protocol

- Multipath TCP use cases

Design objectives

- Multipath TCP is an *evolution* of TCP
- Design objectives
 - Support unmodified applications
 - Work over today's networks
 - Work whenever TCP would work

TCP Connection establishment

- Three-way handshake



SYN, seq=**1234**, Options

SYN+ACK, ack=**1235**, seq=**5678**, Options

ACK, seq=**1235**, ack=**5679**

Data transfer



seq=**1234**,"abcd"

ACK,ack=**1238**,win=4

seq=**1238**,"efgh"

ACK,ack=**1242**,win=0

Connection release

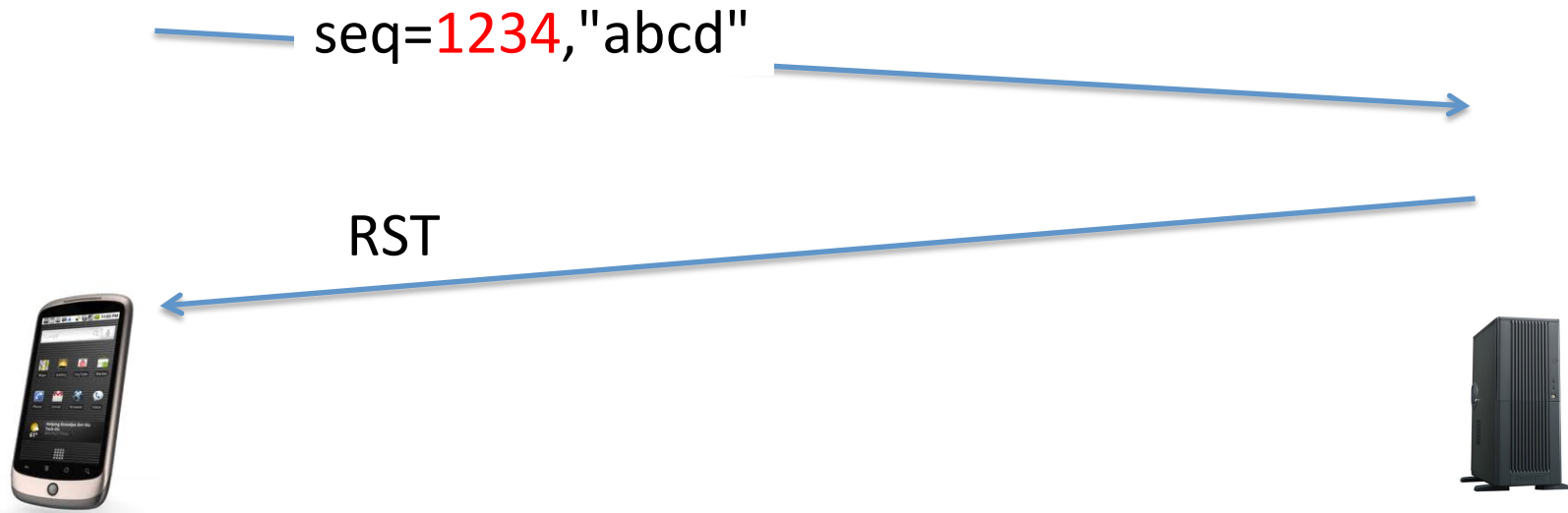

Connection release

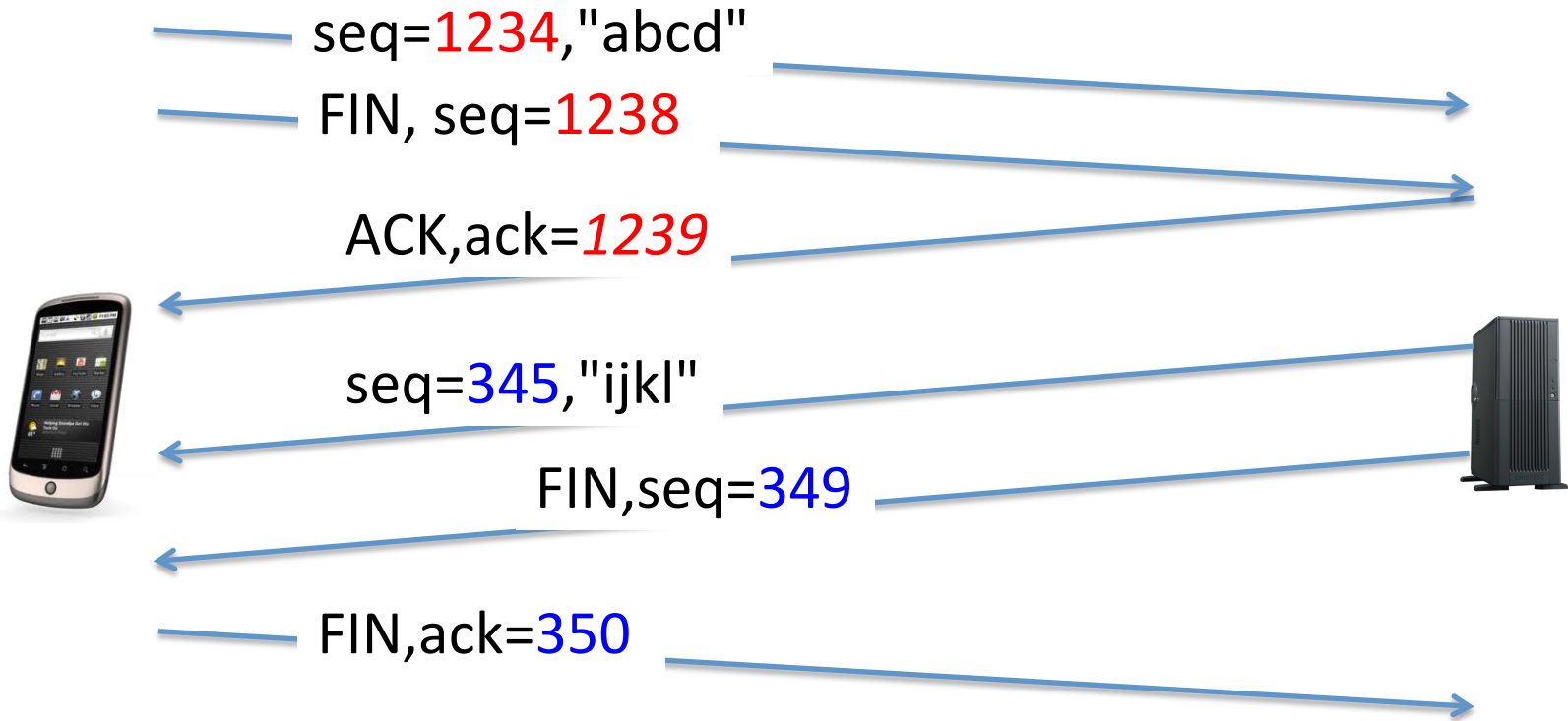

Identification of a TCP connection

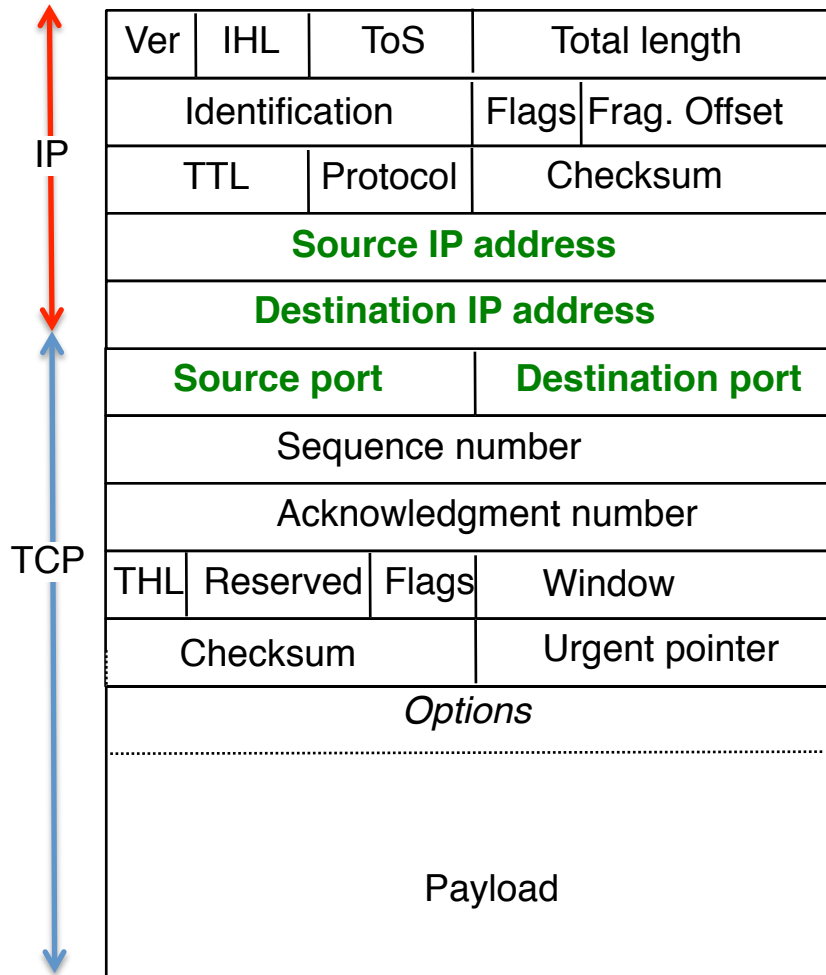

Four tuple

- IP_{source}
- IP_{dest}
- $Port_{source}$
- $Port_{dest}$

All TCP segments contain the four tuple

The *new* bytestream model

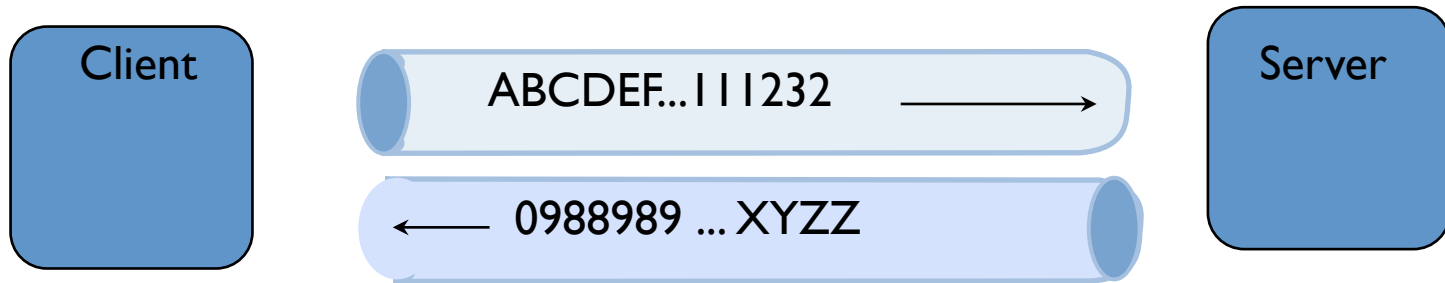

D C B A

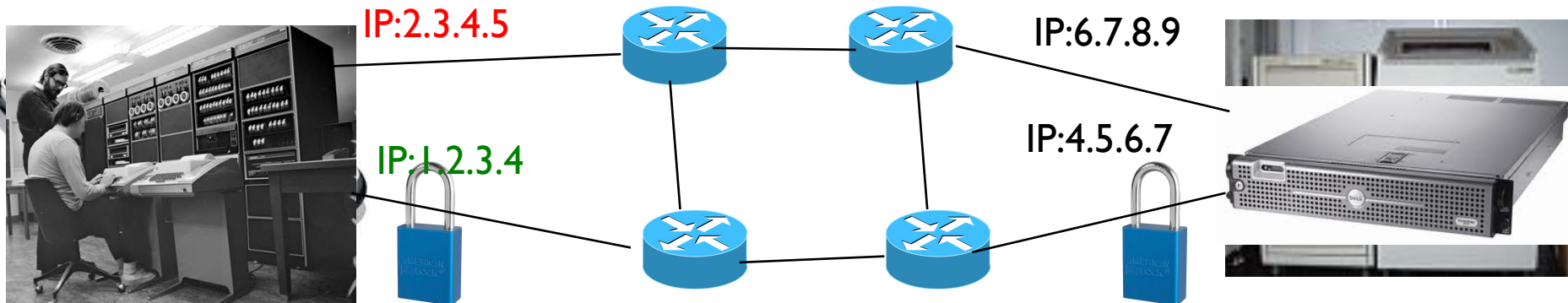

The Multipath TCP protocol

Control plane

- How to manage a Multipath TCP connection that uses several paths ?
- Data plane
 - How to transport data ?
- Congestion control
 - How to control congestion over multiple paths ?

A naïve Multipath TCP

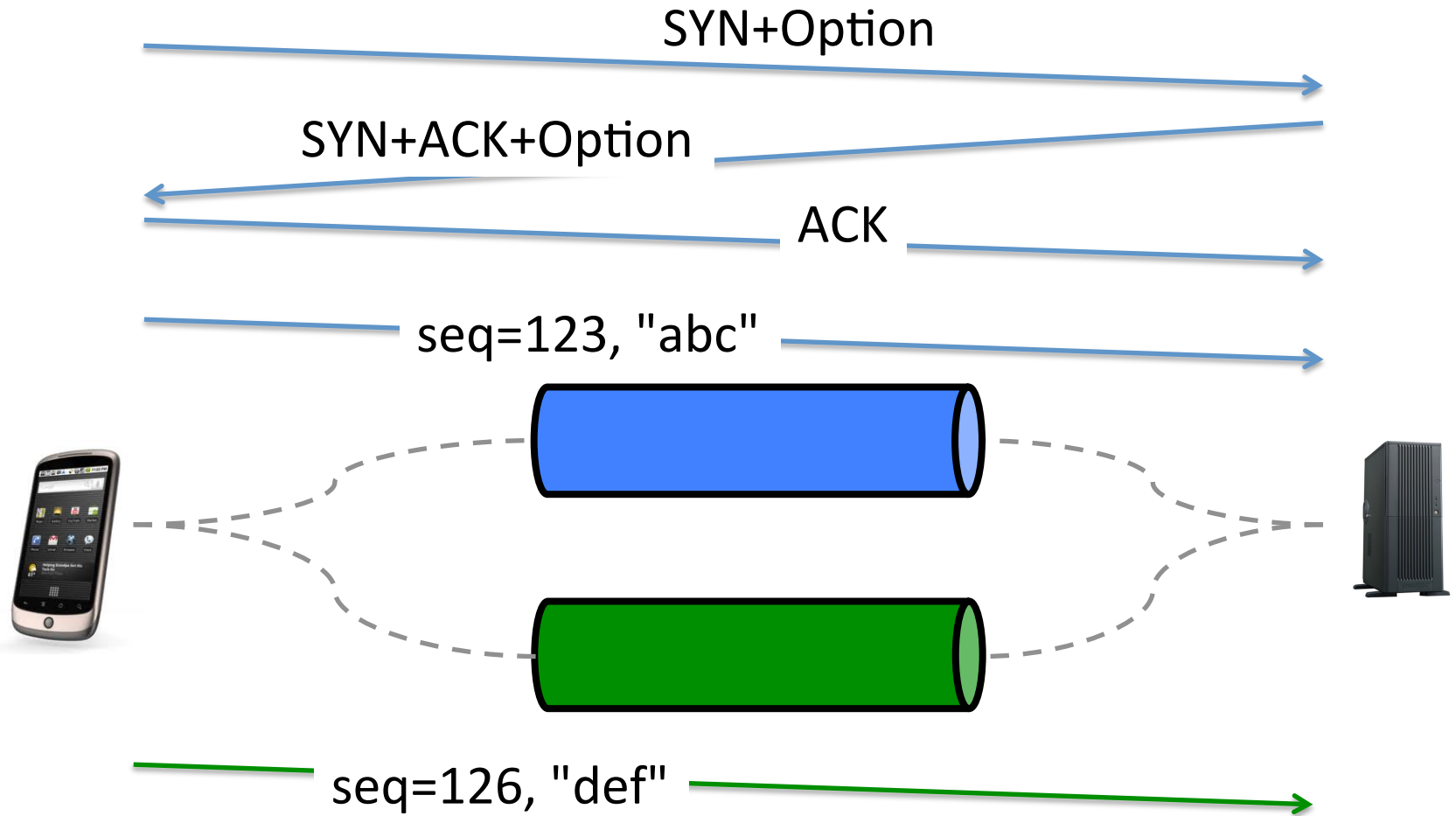

A naïve Multipath TCP In today's Internet ?

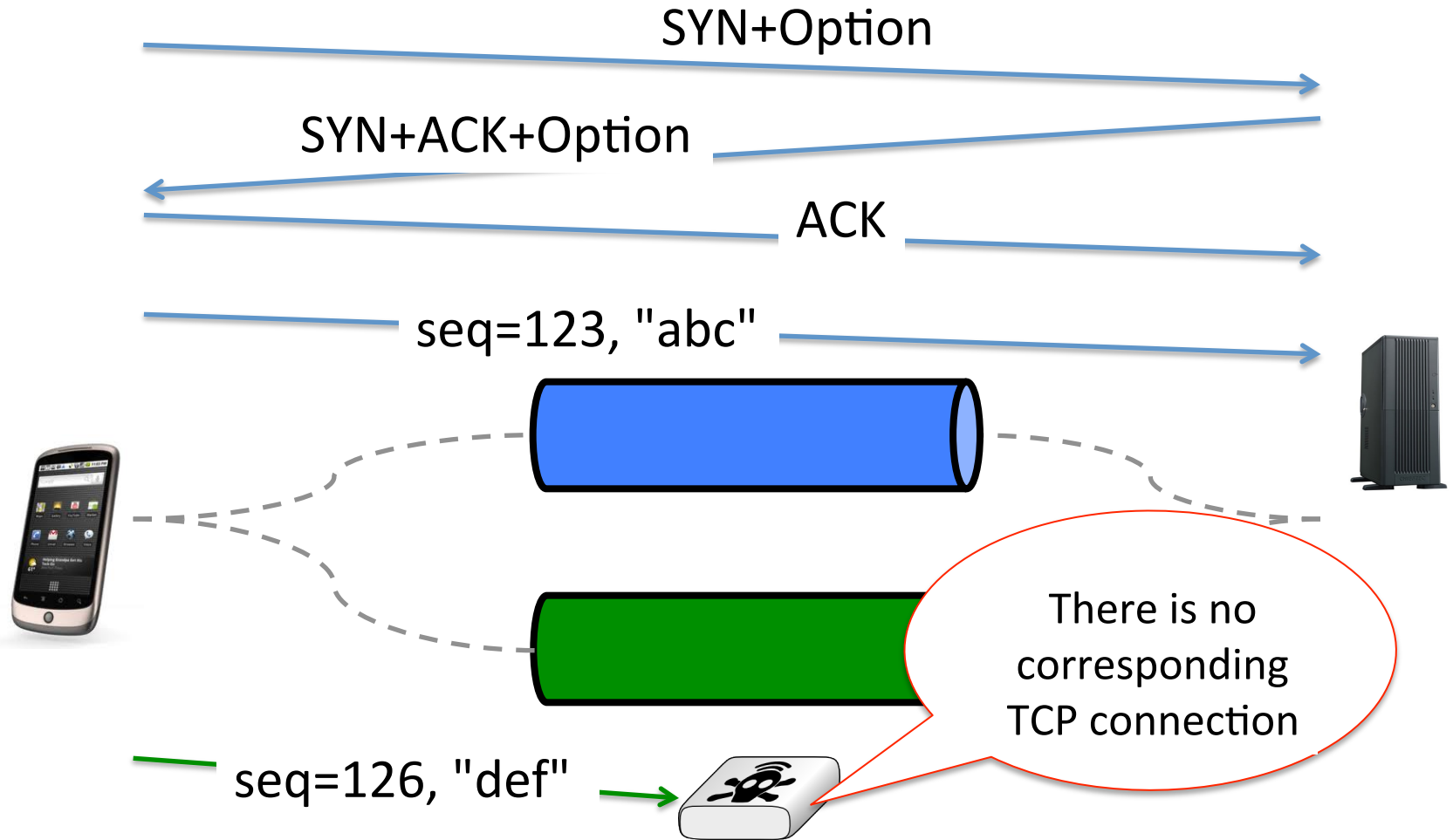

Design decision

- *A Multipath TCP connection is composed of one of more regular TCP subflows that are combined*
 - Each host maintains state that glues the TCP subflows that compose a Multipath TCP connection together
 - Each TCP subflow is sent over a single path and appears like a **regular TCP** connection along this path

Multipath TCP and the architecture

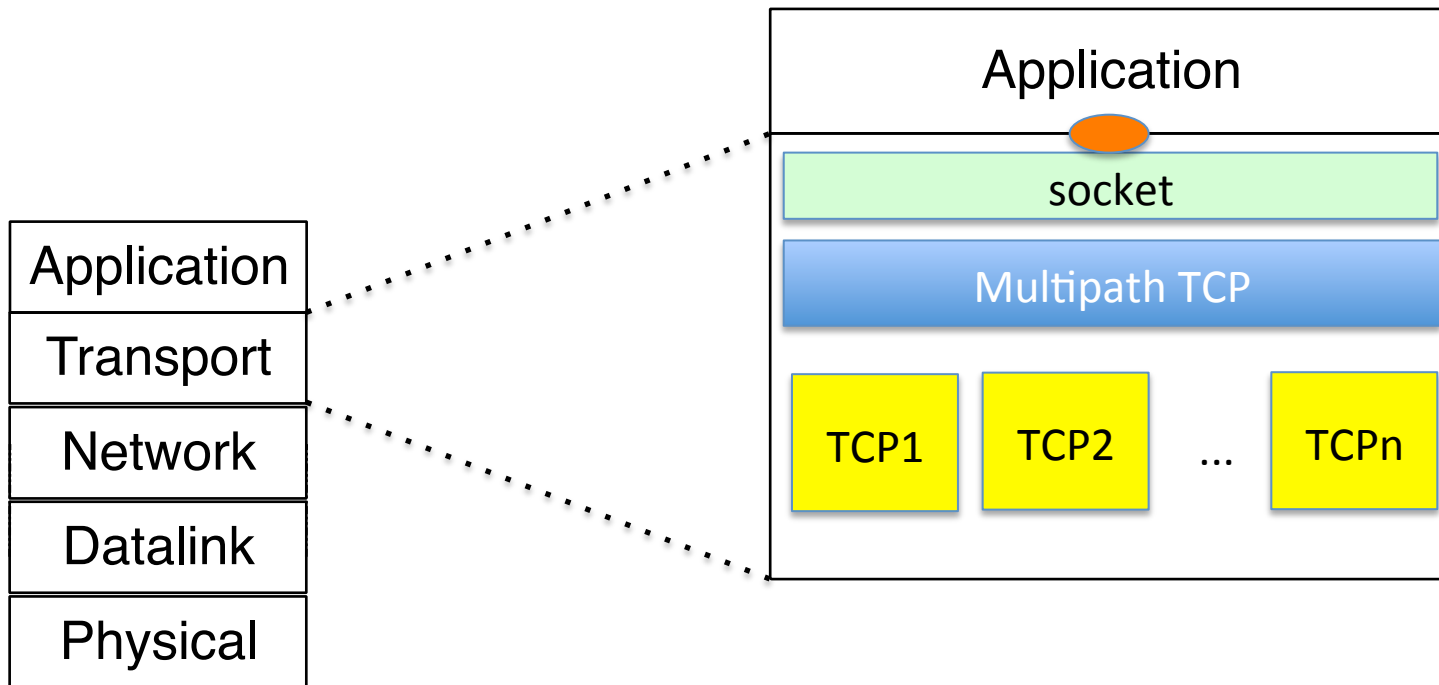

A. Ford, C. Raiciu, M. Handley, S. Barre, and J. Iyengar, "Architectural guidelines for multipath TCP development", RFC6182 2011.

A regular TCP connection

- What is a *regular* TCP connection ?
 - It starts with a three-way handshake
 - SYN segments may contain special options
 - All data segments are sent in sequence
 - There is no gap in the sequence numbers
 - It is terminated by using FIN or RST

Multipath TCP

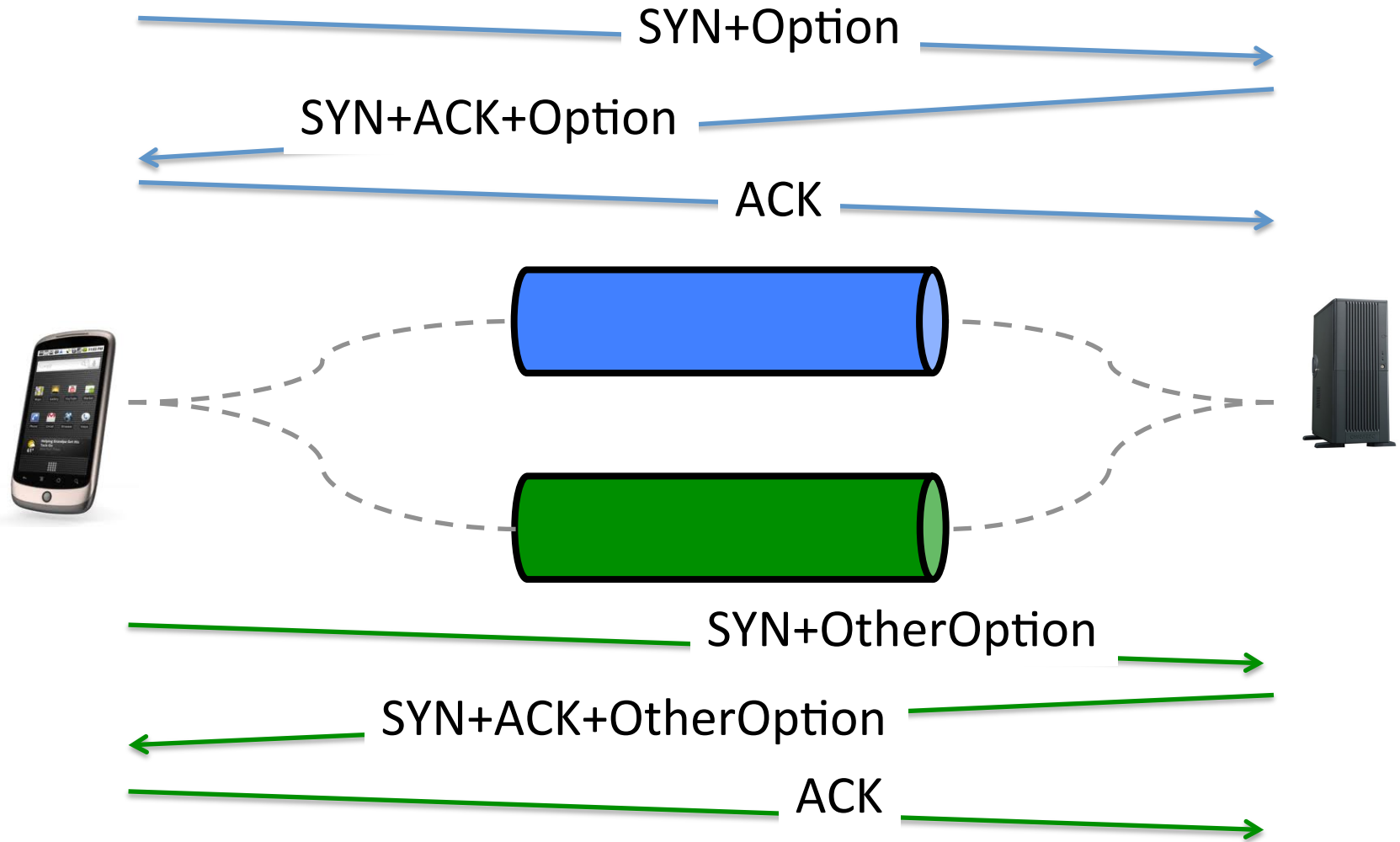

How to combine two TCP subflows ?

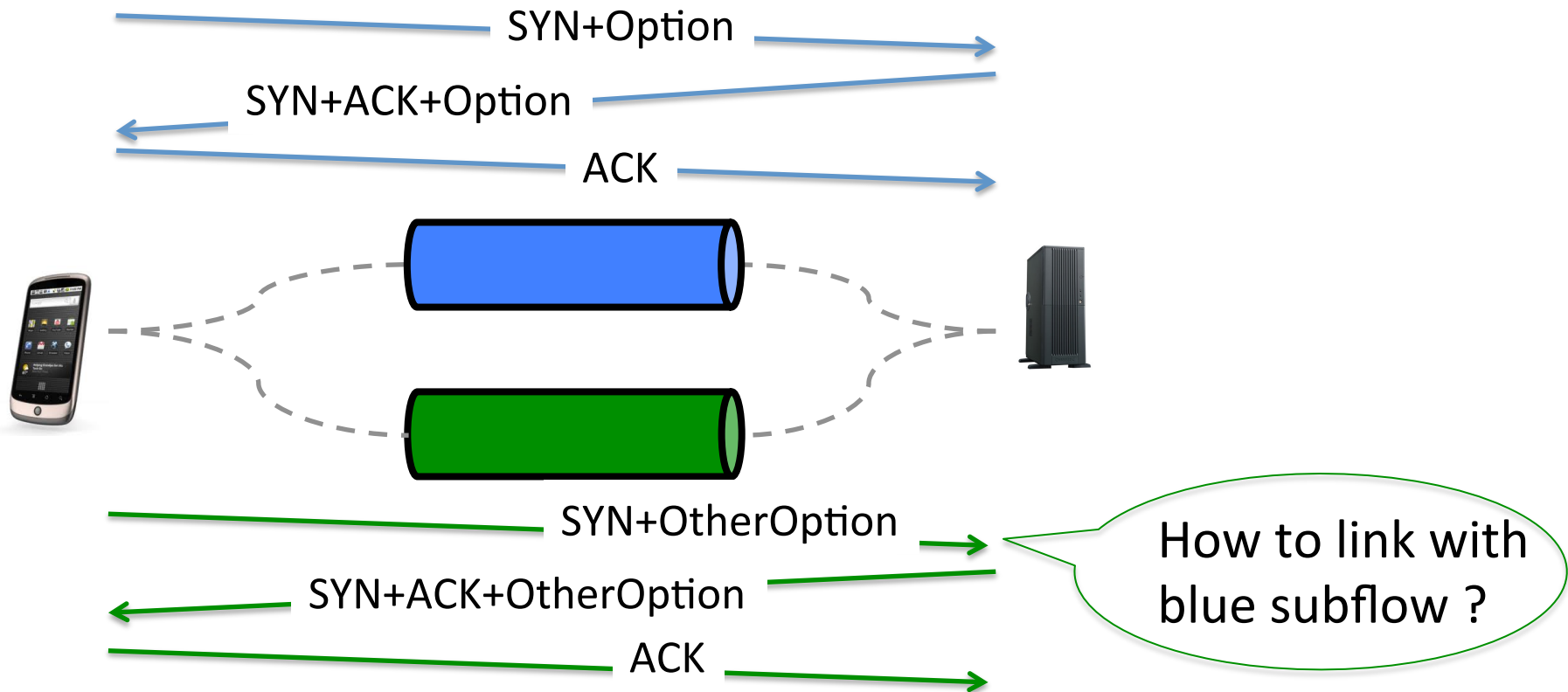

How to link TCP subflows ?

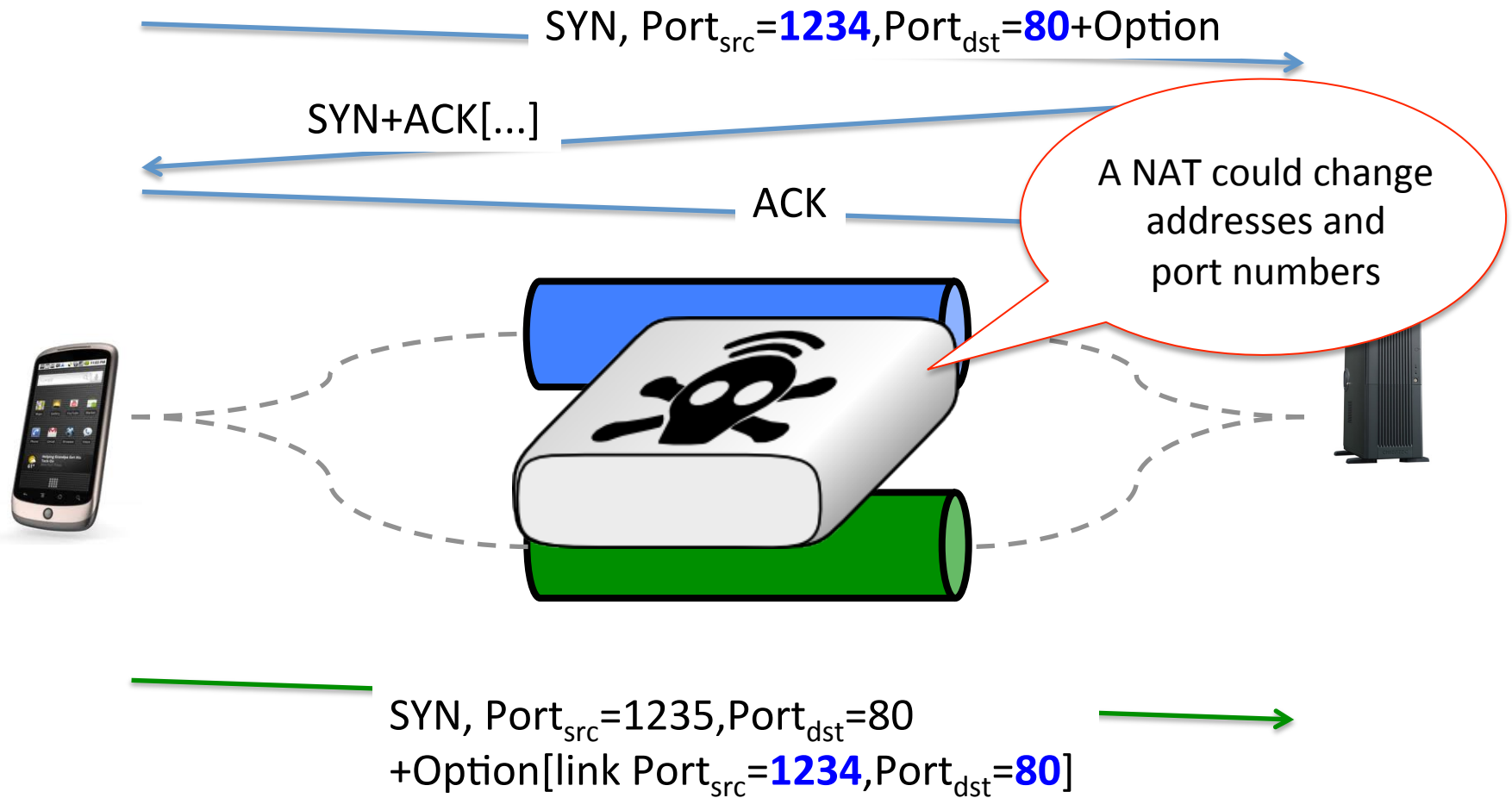

How to link TCP subflows ?

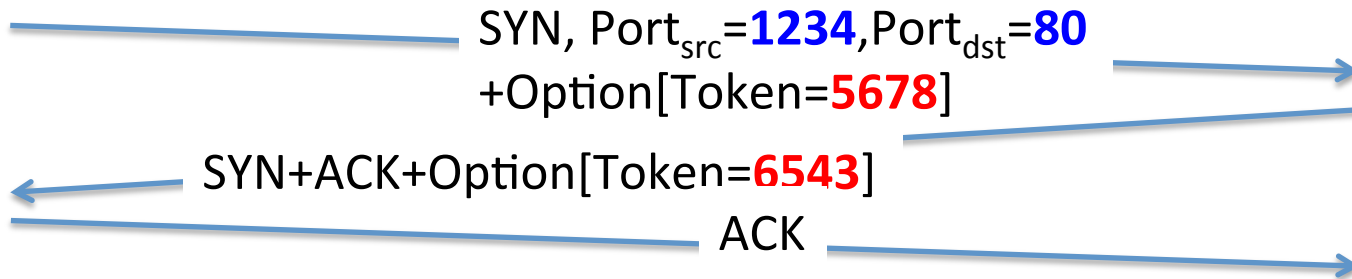

MyToken=5678

YourToken=6543

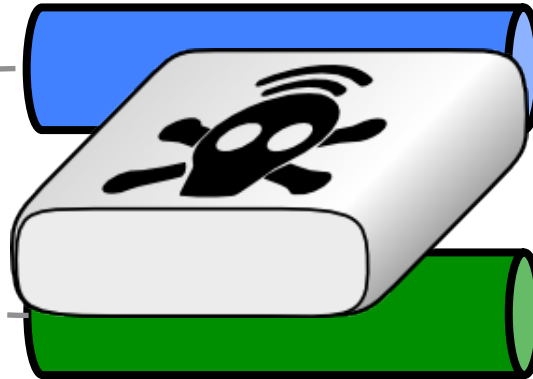

MyToken=6543

YourToken=5678

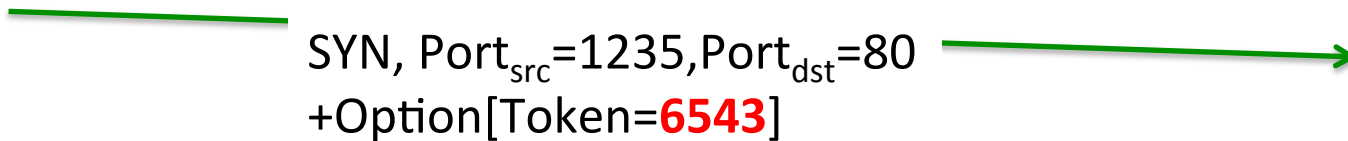

Subflow agility

- Multipath TCP supports
 - addition of subflows
 - removal of subflows

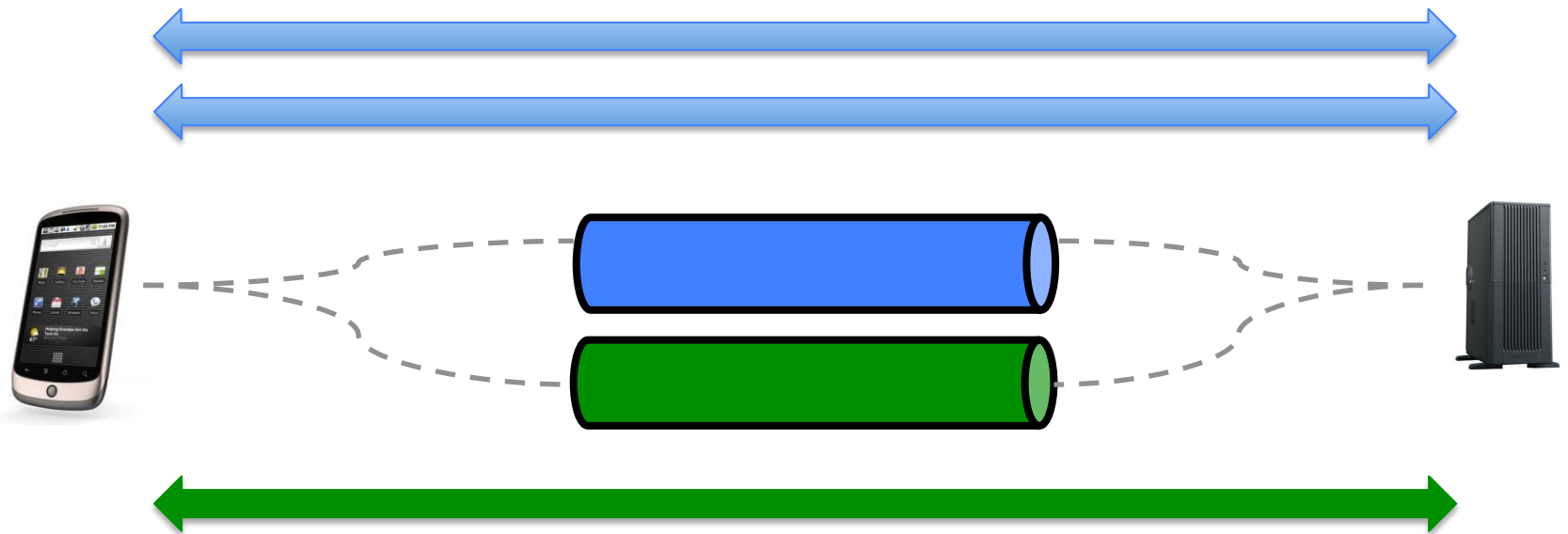

TCP subflows

- Which subflows can be associated to a Multipath TCP connection ?
 - At least one of the elements of the four-tuple needs to differ between two subflows
 - Local IP address
 - Remote IP address
 - Local port
 - Remote port

The Multipath TCP protocol

- Control plane
 - How to manage a Multipath TCP connection that uses several paths ?
- ➔ **Data plane**
 - How to transport data ?
- Congestion control
 - How to control congestion over multiple paths ?

How to transfer data ?

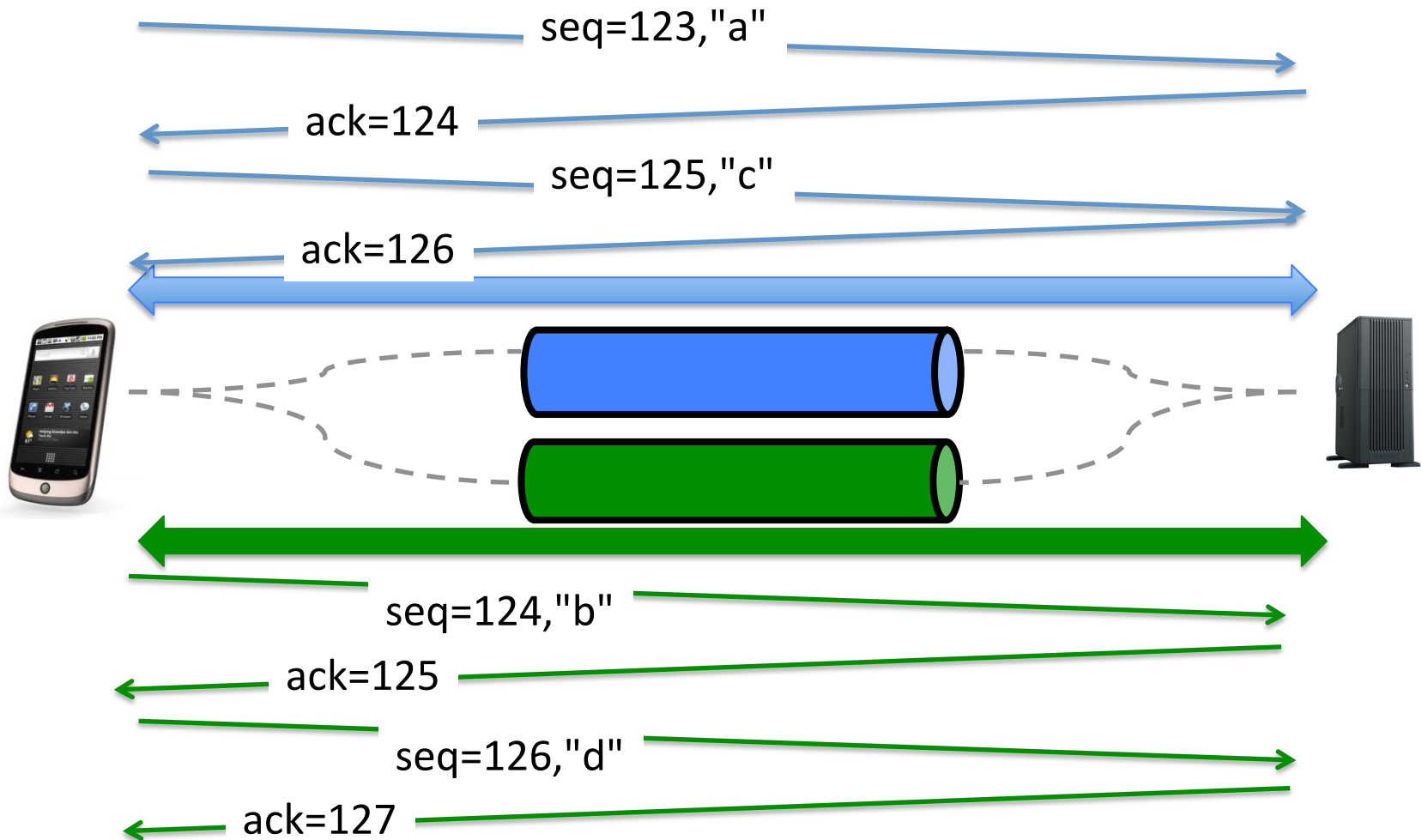

How to transfer data in today's Internet ?

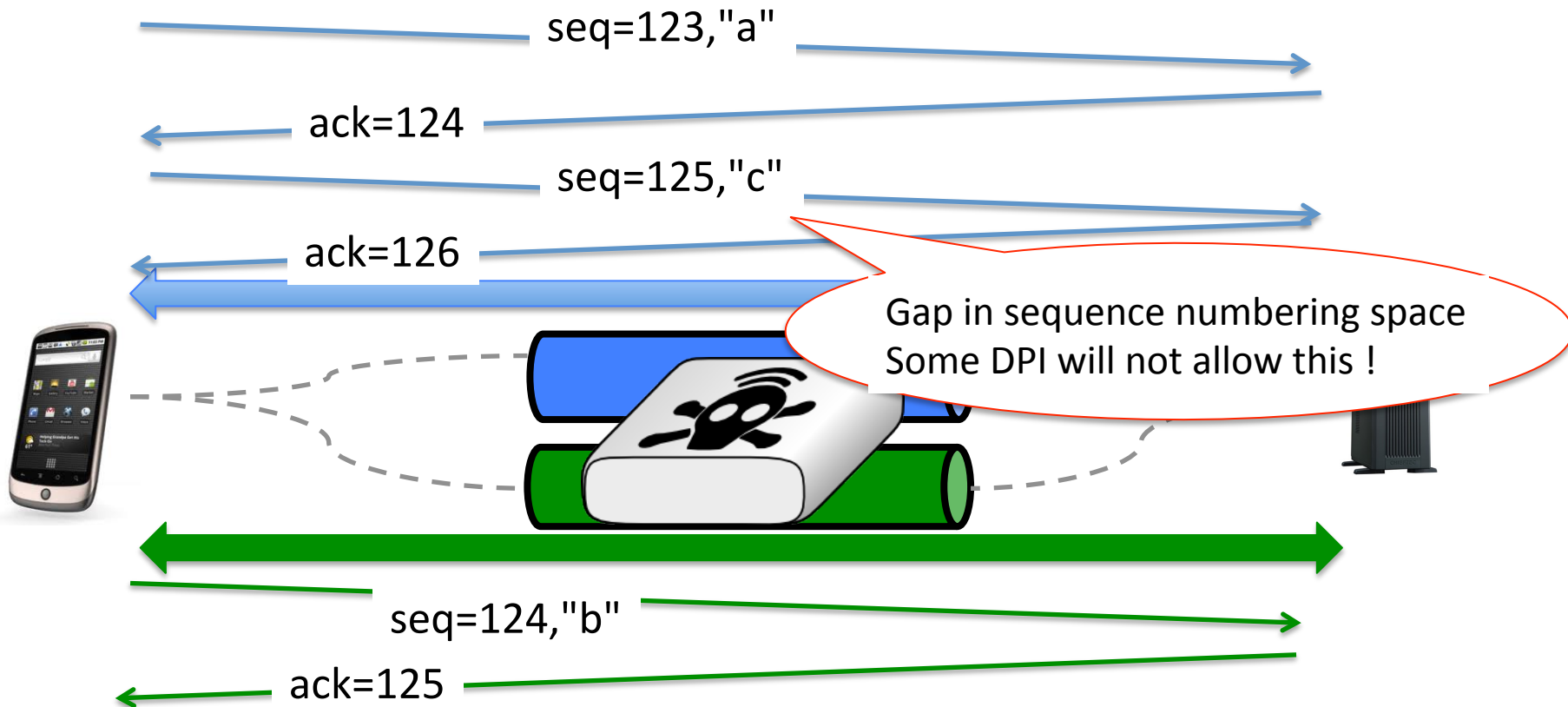

Multipath TCP Data transfer

- Two levels of sequence numbers

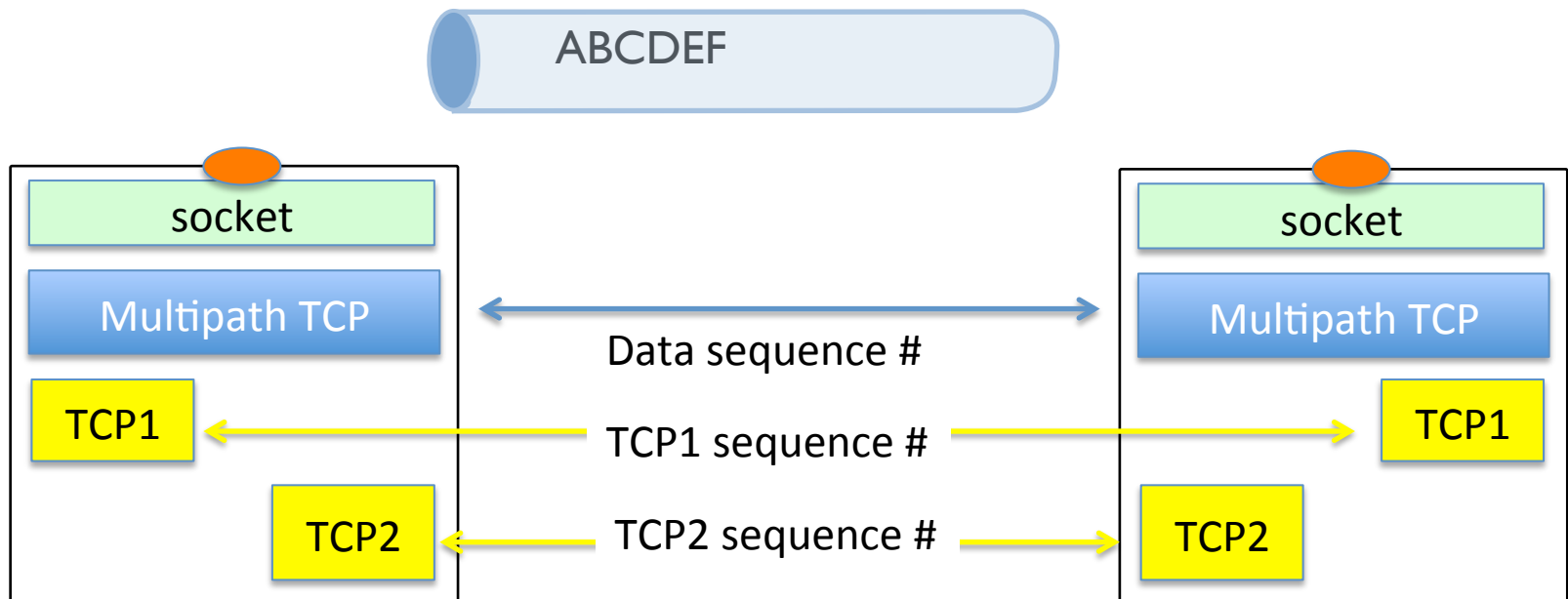

Multipath TCP Data transfer

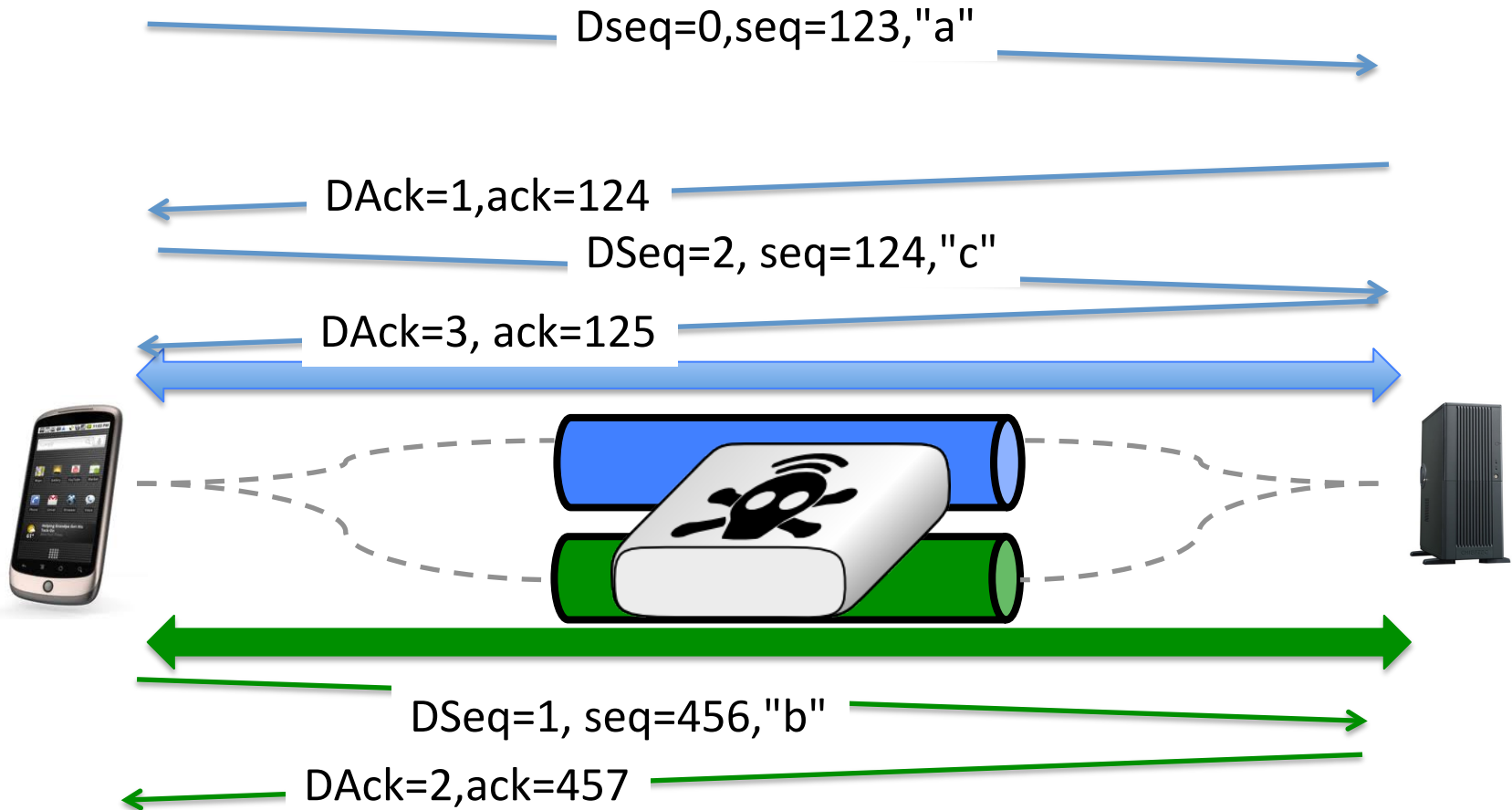

Multipath TCP

How to deal with losses ?

- Data losses over one TCP subflow
 - Fast retransmit and timeout as in regular TCP

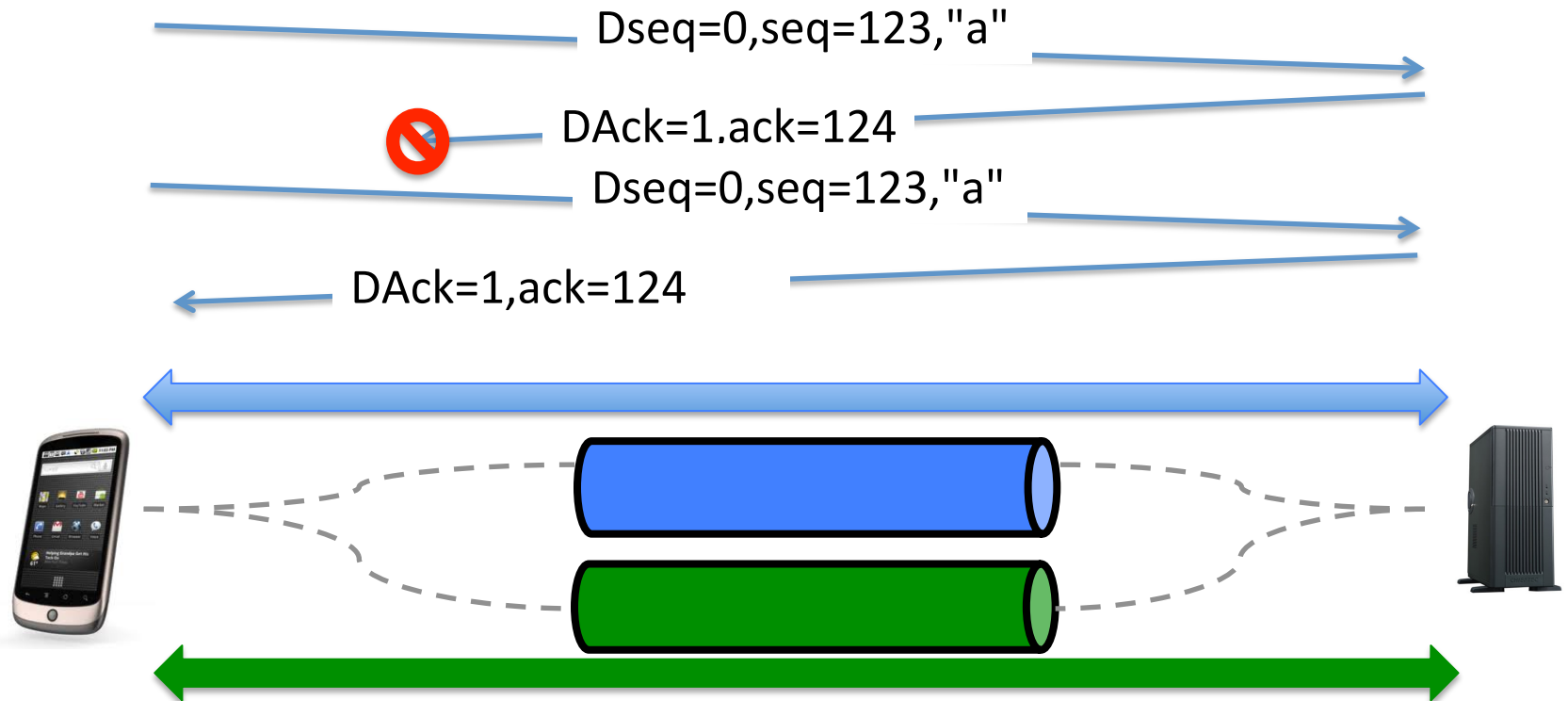

Multipath TCP

- What happens when a TCP subflow fails ?

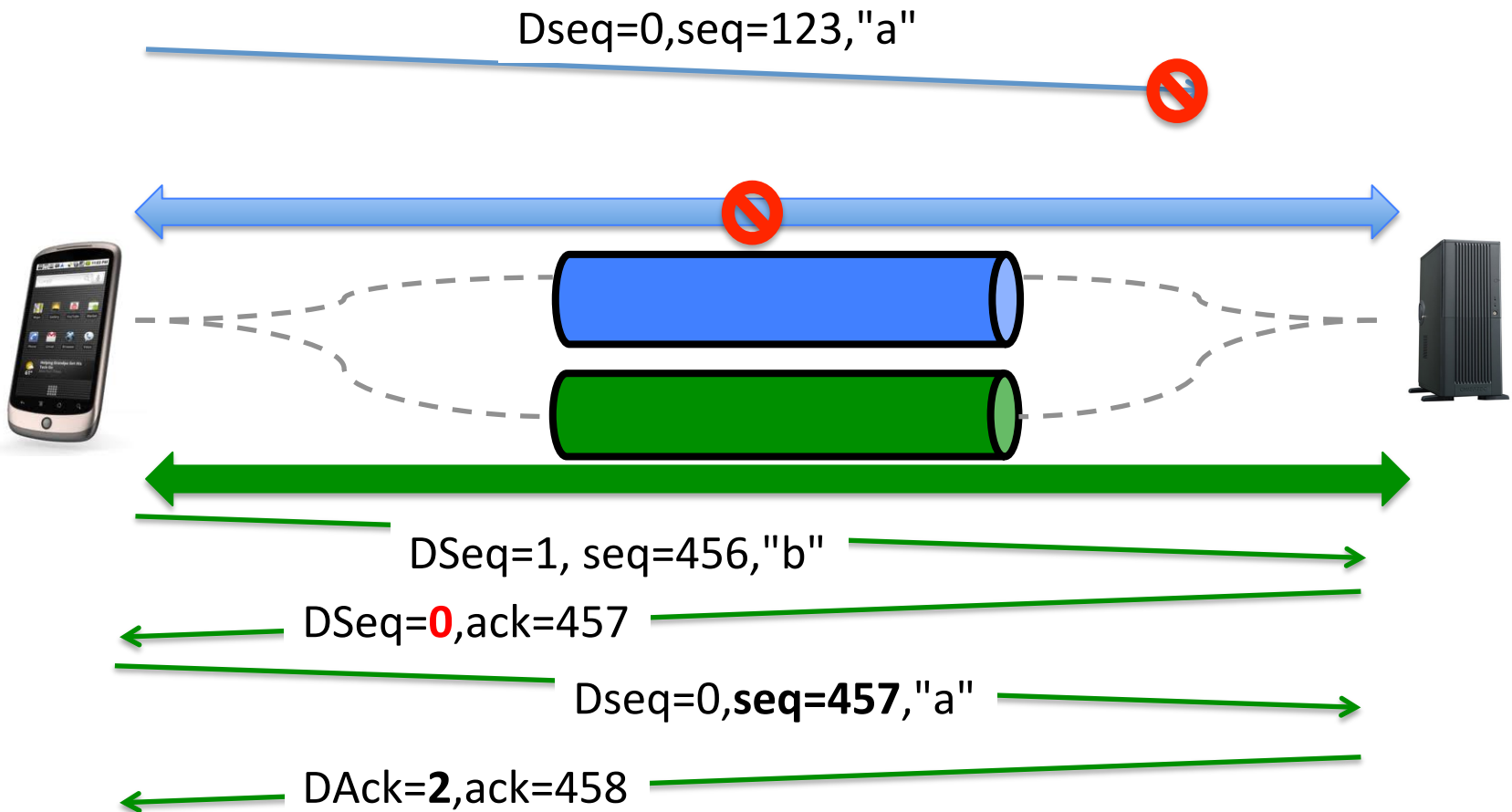

Retransmission heuristics

- Heuristics used by current Linux implementation
 - Fast retransmit is performed on the same subflow as the original transmission
 - Upon timeout expiration, reevaluate whether the segment could be retransmitted over another subflow
 - Upon loss of a subflow, all the unacknowledged data are retransmitted on other subflows

Flow control

- How should the window-based flow control be performed ?
 - Independant windows on each TCP subflow
 - A single window that is shared among all TCP subflows

Independant windows

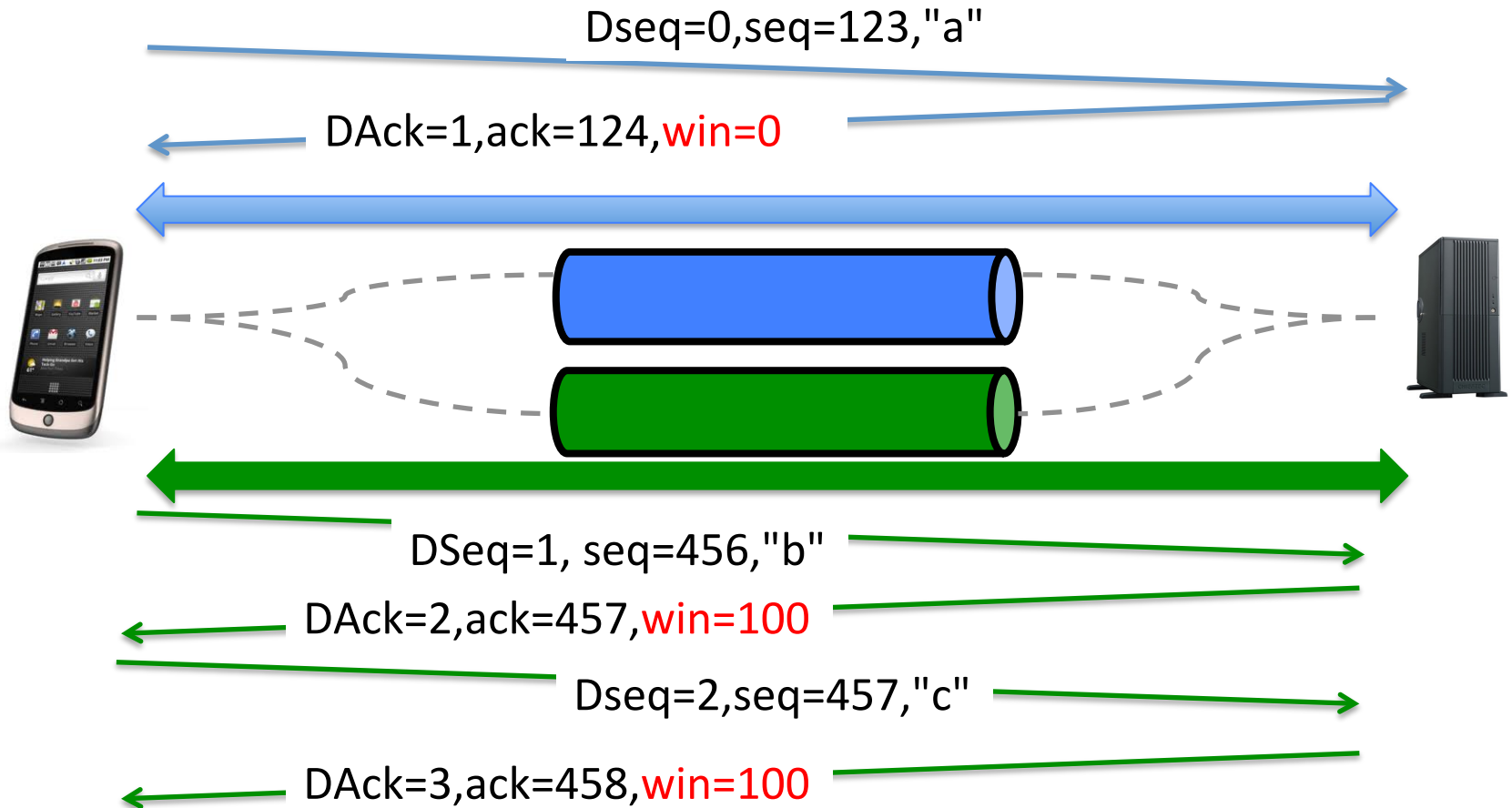

Independant windows possible problem

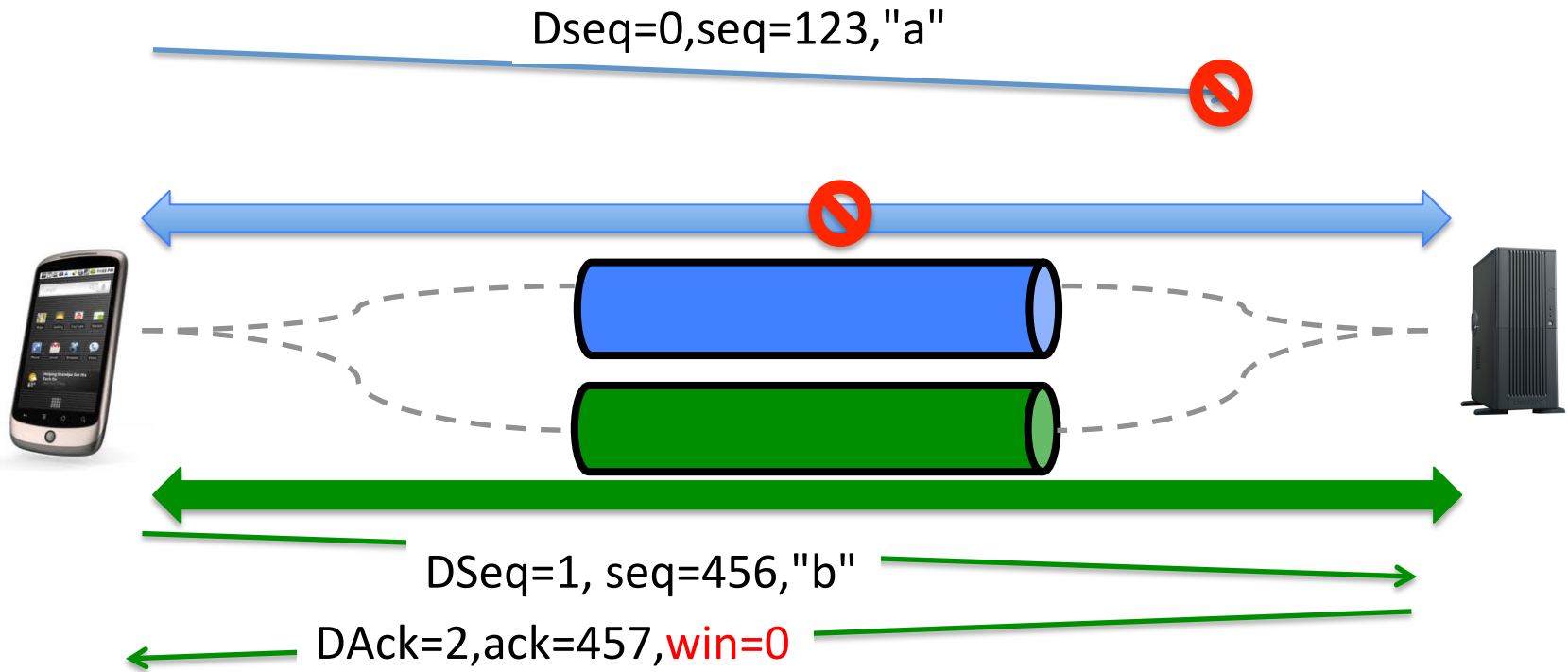

- Impossible to retransmit, window is already full on green subflow

A single window shared by all subflows

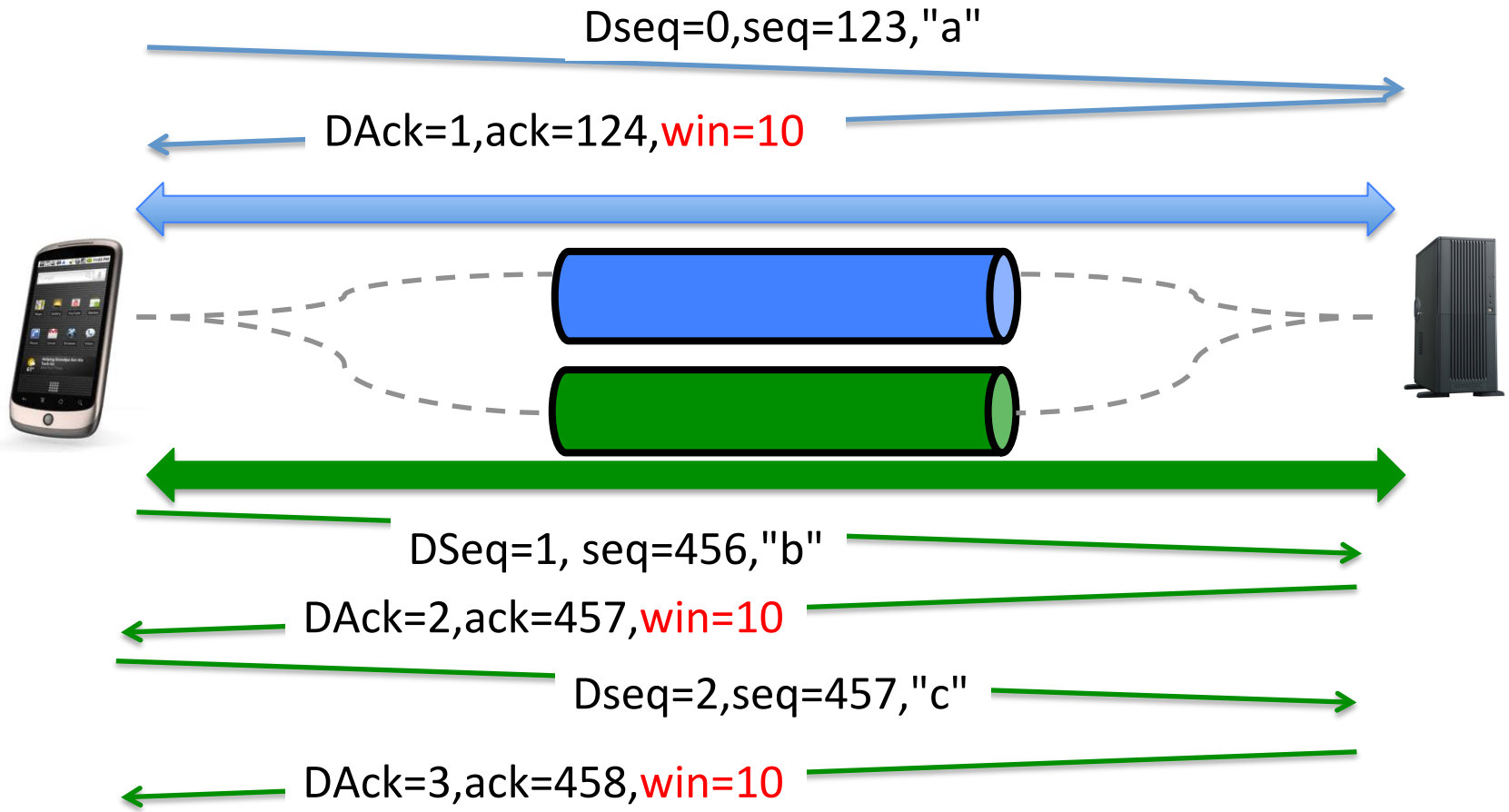

A single window shared by all subflows

Impact of middleboxes

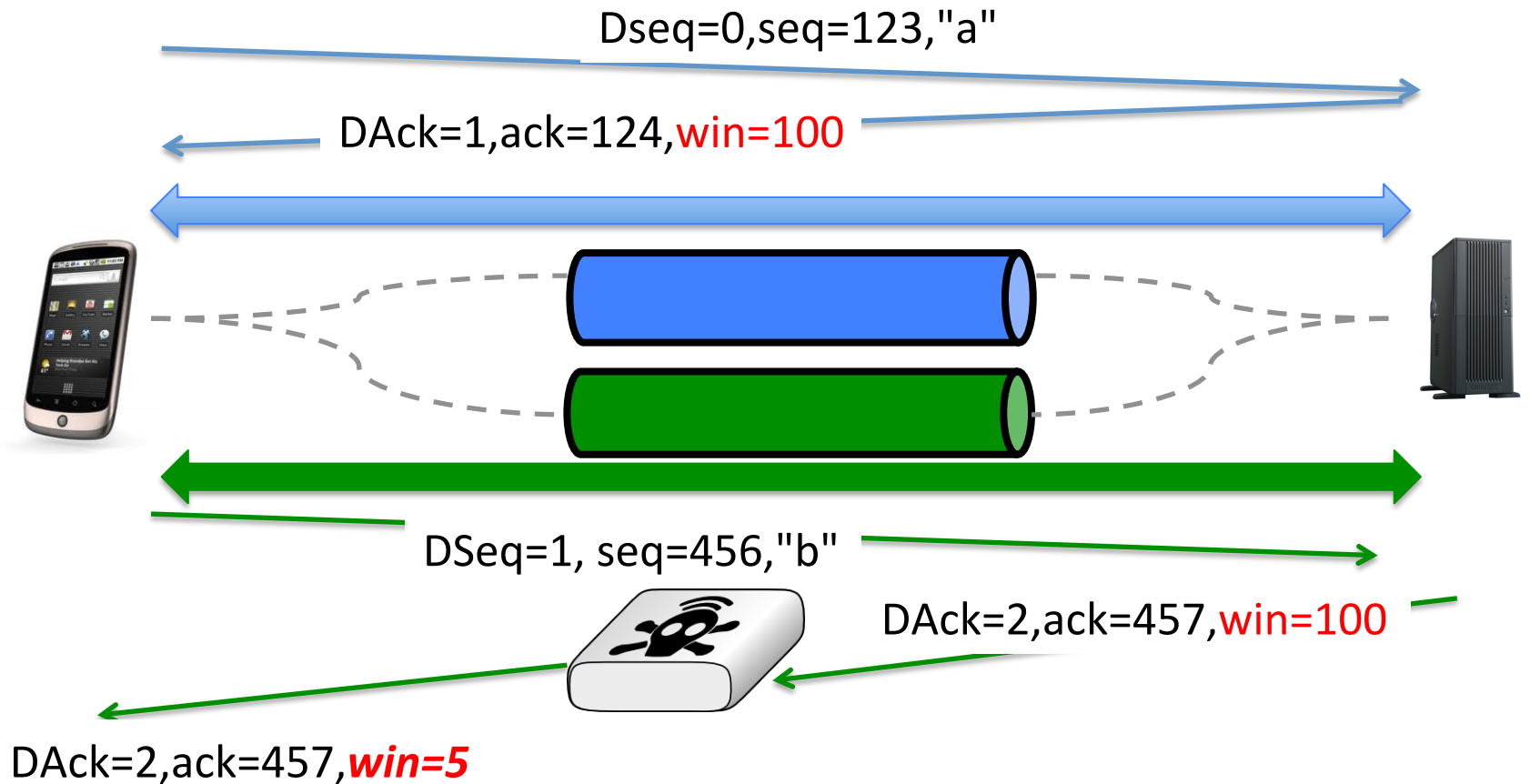

Multipath TCP Windows

- Multipath TCP maintains one window per Multipath TCP connection
 - Window is relative to the last acked data (Data Ack)
 - Window is shared among all subflows
 - It's up to the implementation to decide how the window is shared
 - Window is transmitted inside the `window` field of the regular TCP header
 - If middleboxes change `window` field,
 - use largest `window` received at MPTCP-level
 - use received `window` over each subflow to cope with the flow control imposed by the middlebox

Multipath TCP buffers

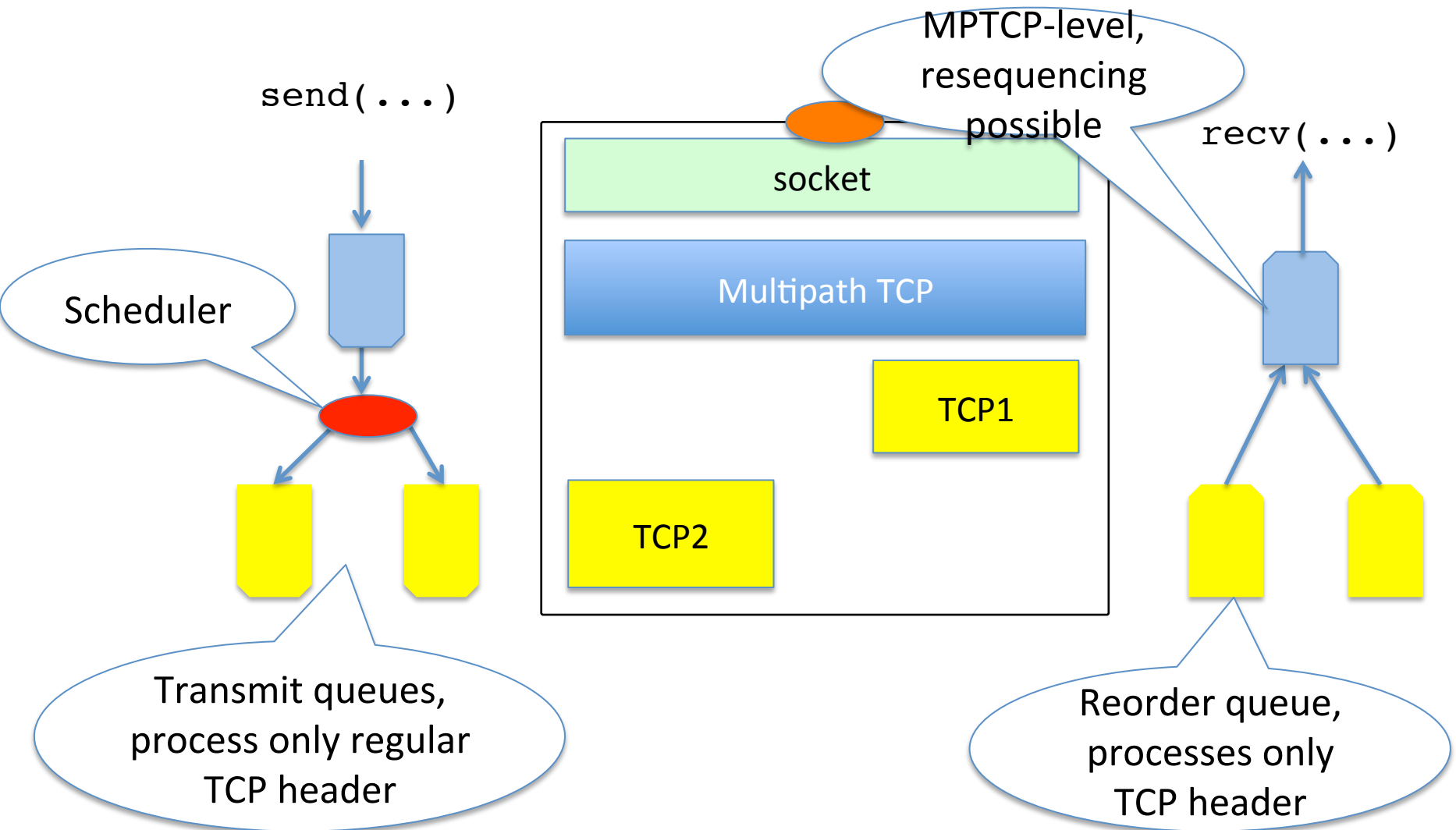

Multipath TCP

- How to exchange the Multipath TCP specific information between two hosts ?
- Option 1
 - Use TLVs to encode data and control information inside subflows
- Option 2
 - Use TCP options to encode all Multipath TCP information

Multipath TCP with only options

- Advantages
 - Normal way of extending TCP
 - Should be able to go through middleboxes or fallback
- Drawbacks
 - limited size of the TCP options, notably inside SYN
 - What happens when middleboxes drop TCP options in data segments

Multipath TCP using TLV

- Advantages
 - Multipath TCP could start as regular TCP and move to Multipath only when needed
 - Could be implemented as a library in userspace
 - TLVs can be easily extended
- Drawbacks
 - TCP segments contain TLVs including the data and not only the data
 - problem for middleboxes, DPI, ..
 - Middleboxes become more difficult

Multipath TCP options

- TCP option format



- Initial design
 - One option kind for each purpose (e.g. Data Sequence number)
- Final design
 - A single variable-length Multipath TCP option

Multipath TCP option

- A single option type
 - to minimise the risk of having one option accepted by middleboxes in SYN segments and rejected in segments carrying data

Kind	Length	Subtype	
Subtype specific data (variable length)			

TCP options

- Known option (TS) in Data segments

Data segments, port 34443

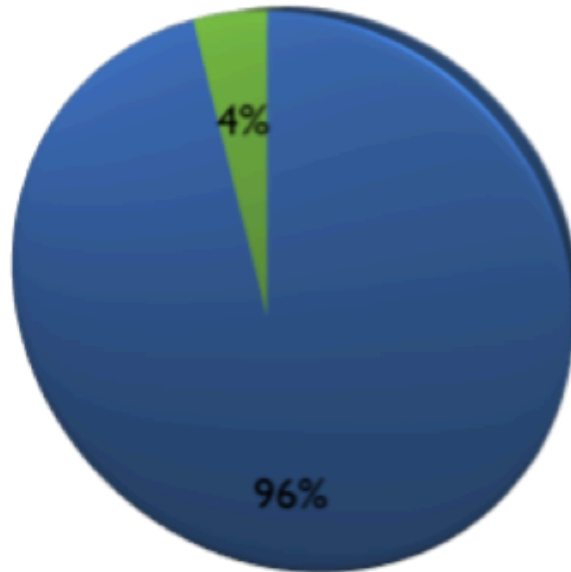

Data segments, port 80

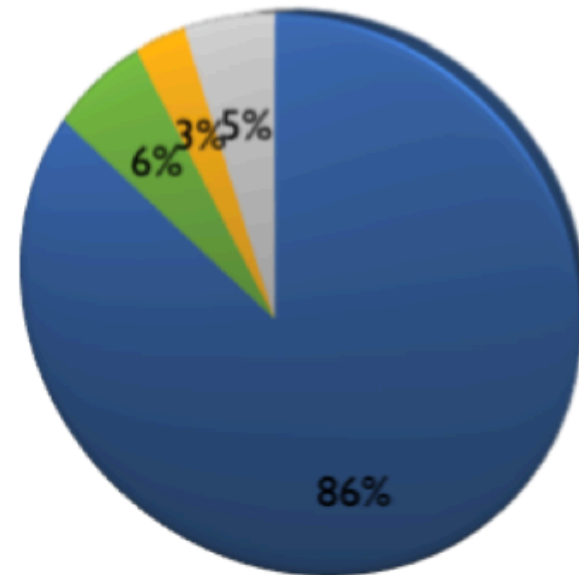

TCP options

- Unknown option in Data segments

Data segments, port 34443

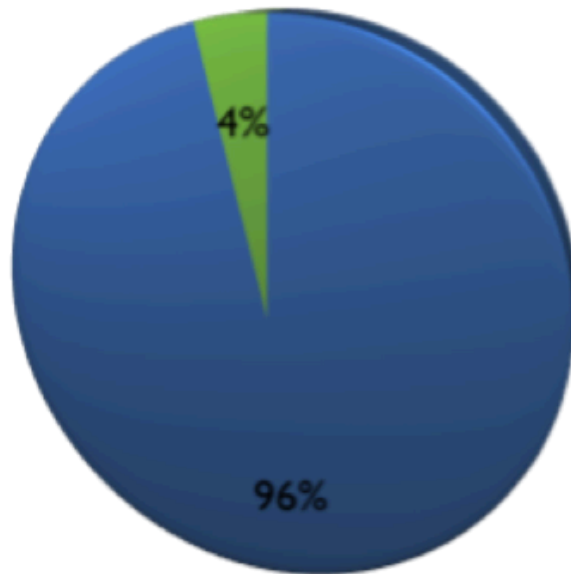

Data segments, port 80

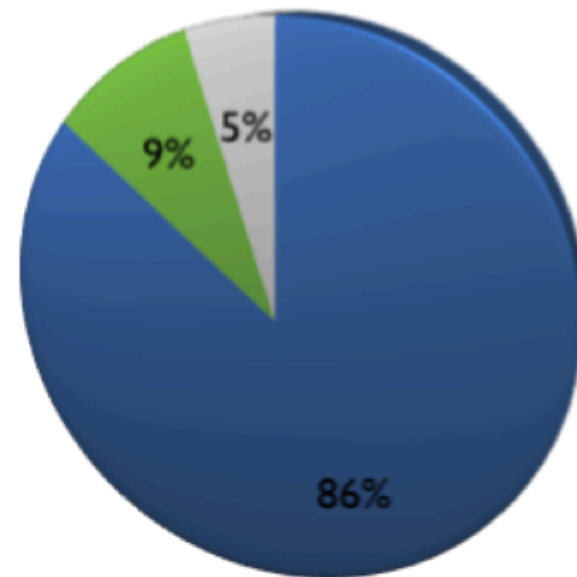

Data sequence numbers and TCP segments

- How to transport Data sequence numbers ?
 - Same solution as for TCP
 - Data sequence number in TCP option is the Data sequence number of the first byte of the segment

Source port		Destination port	
Sequence number			
Acknowledgment number			
THL	Reserved	Flags	Window
Checksum		Urgent pointer	
<i>Datasequence number</i>			
Payload			

Multipath TCP Data transfer

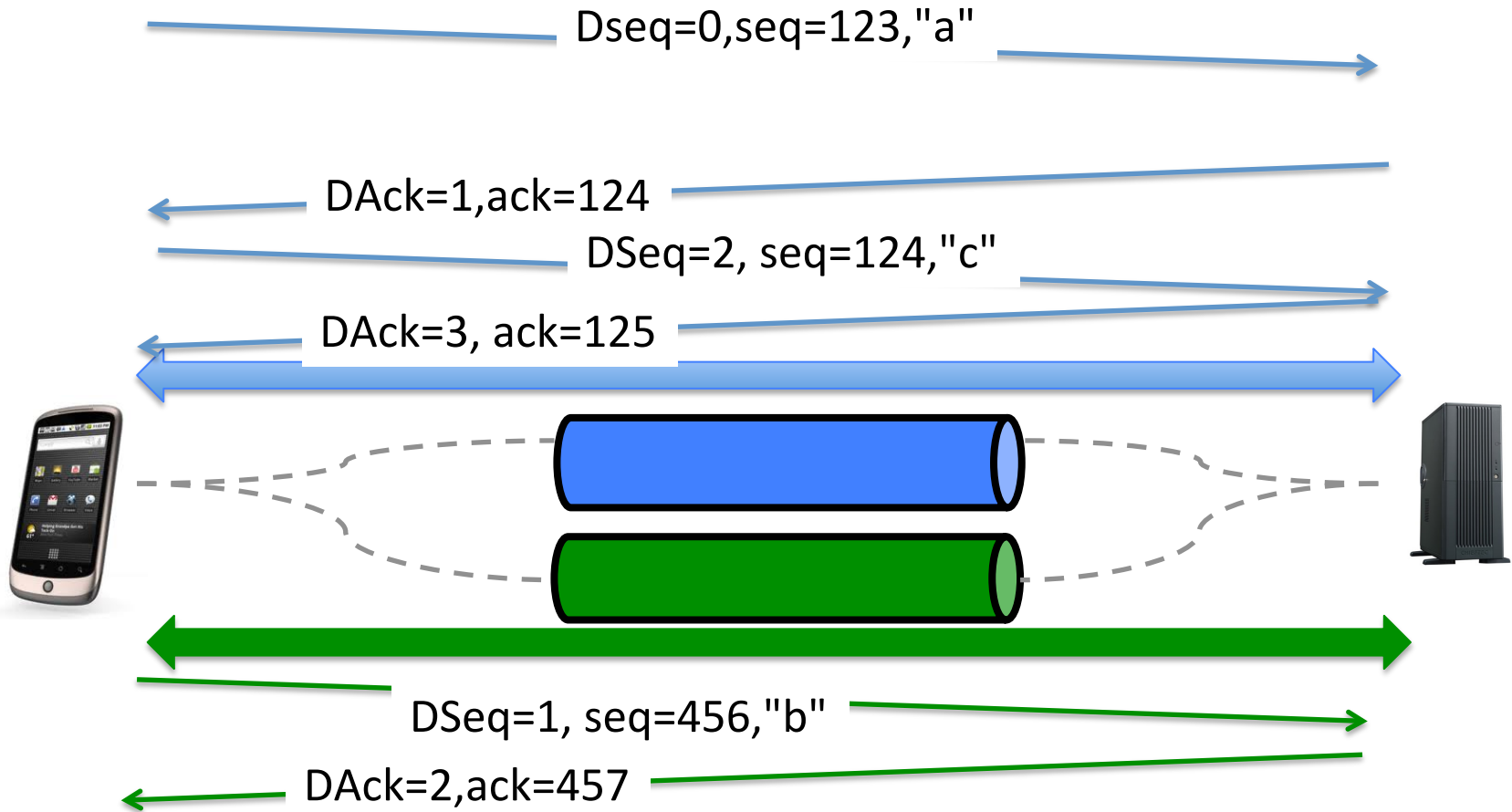

TCP sequence number and middleboxes

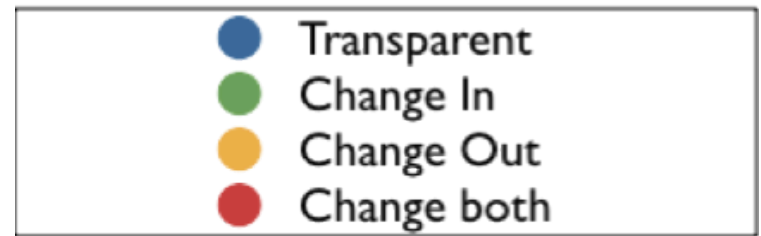
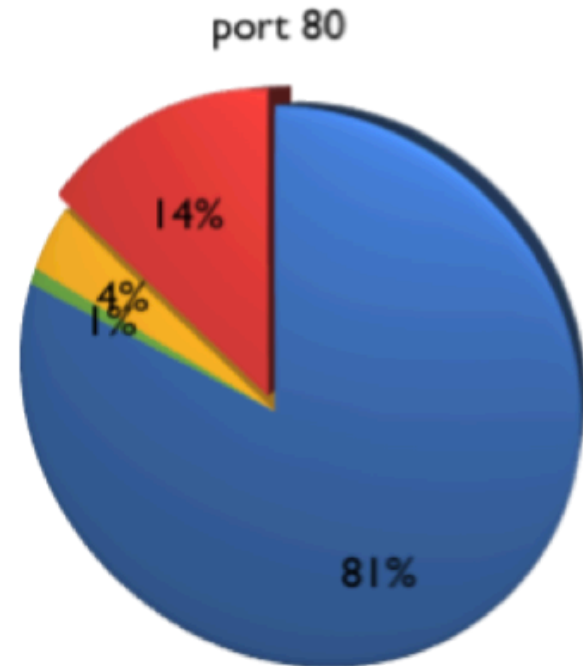
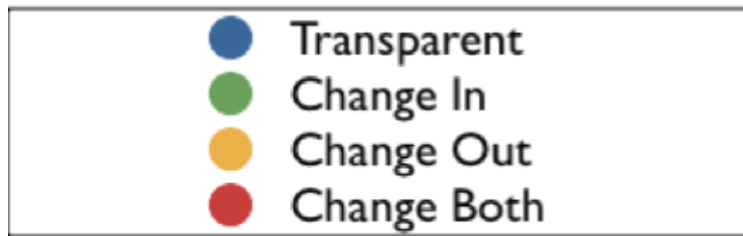
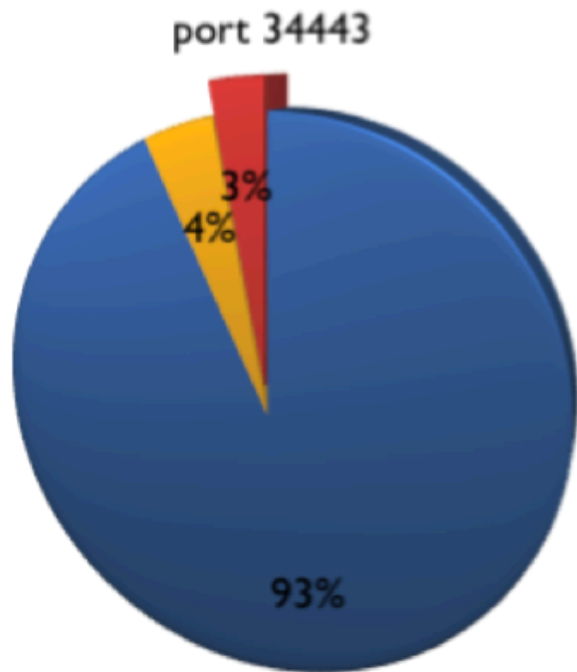

Which middleboxes change TCP sequence numbers ?

- Some firewalls change TCP sequence numbers in SYN segments to ensure randomness
 - fix for old windows95 bug
- Transparent proxies terminate TCP connections

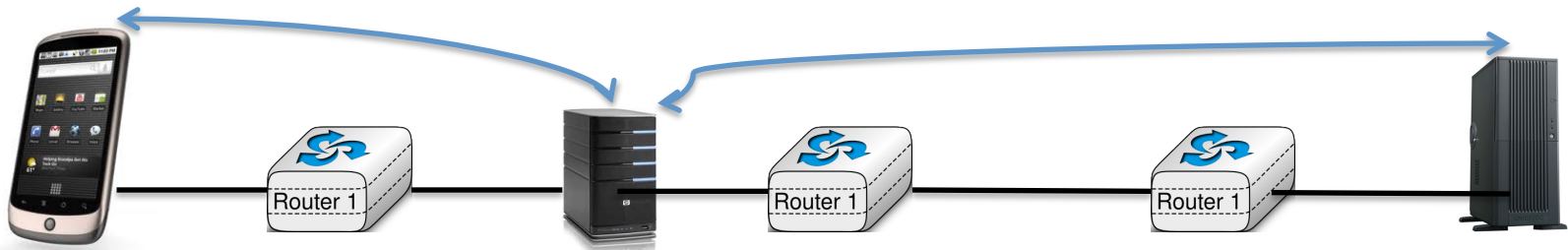

Other types of middlebox interference

- Data segments

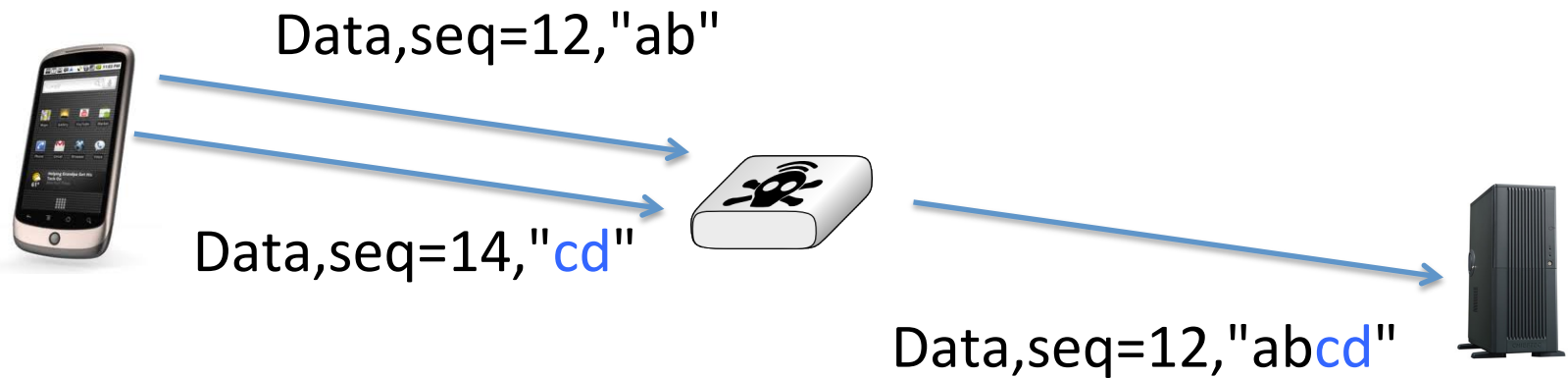

Segment coalescing

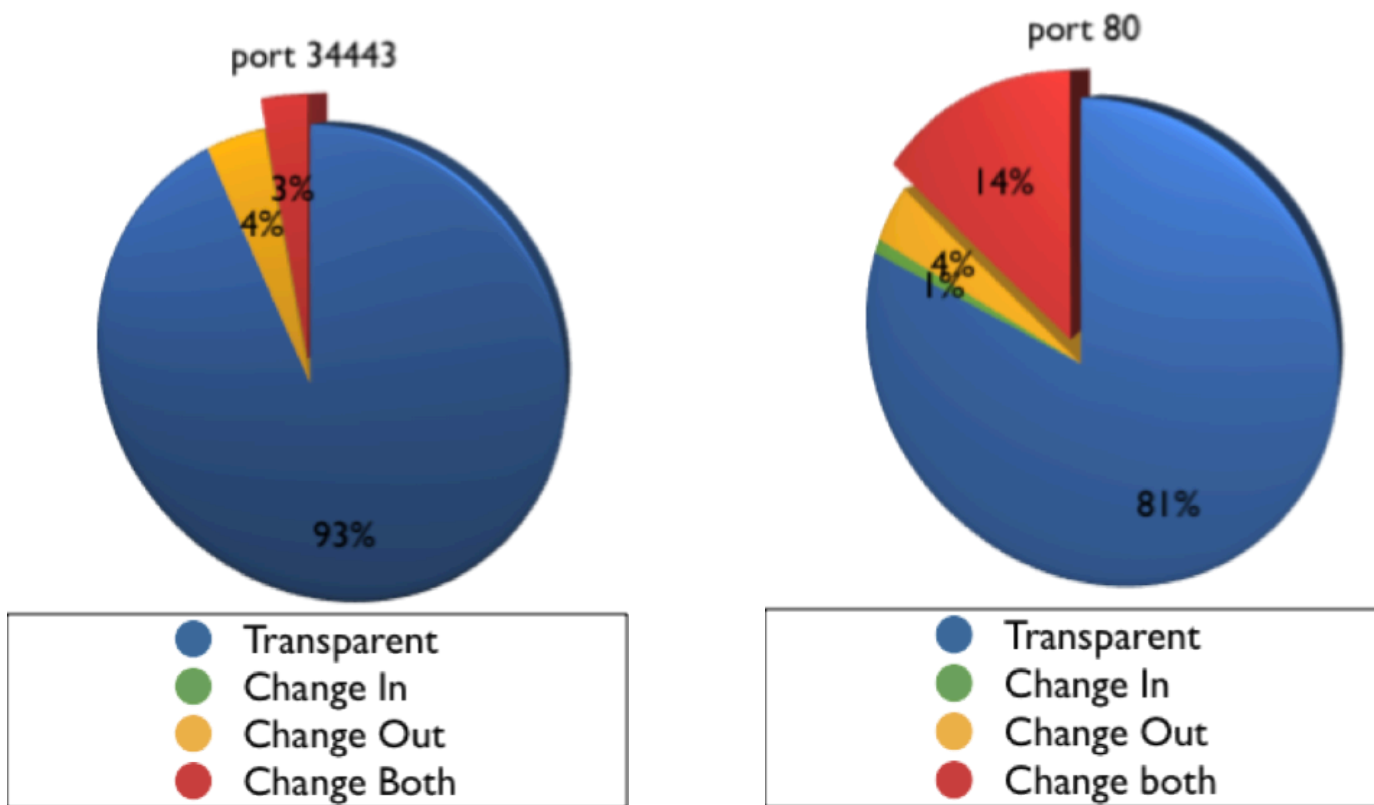

Data sequence numbers and middleboxes

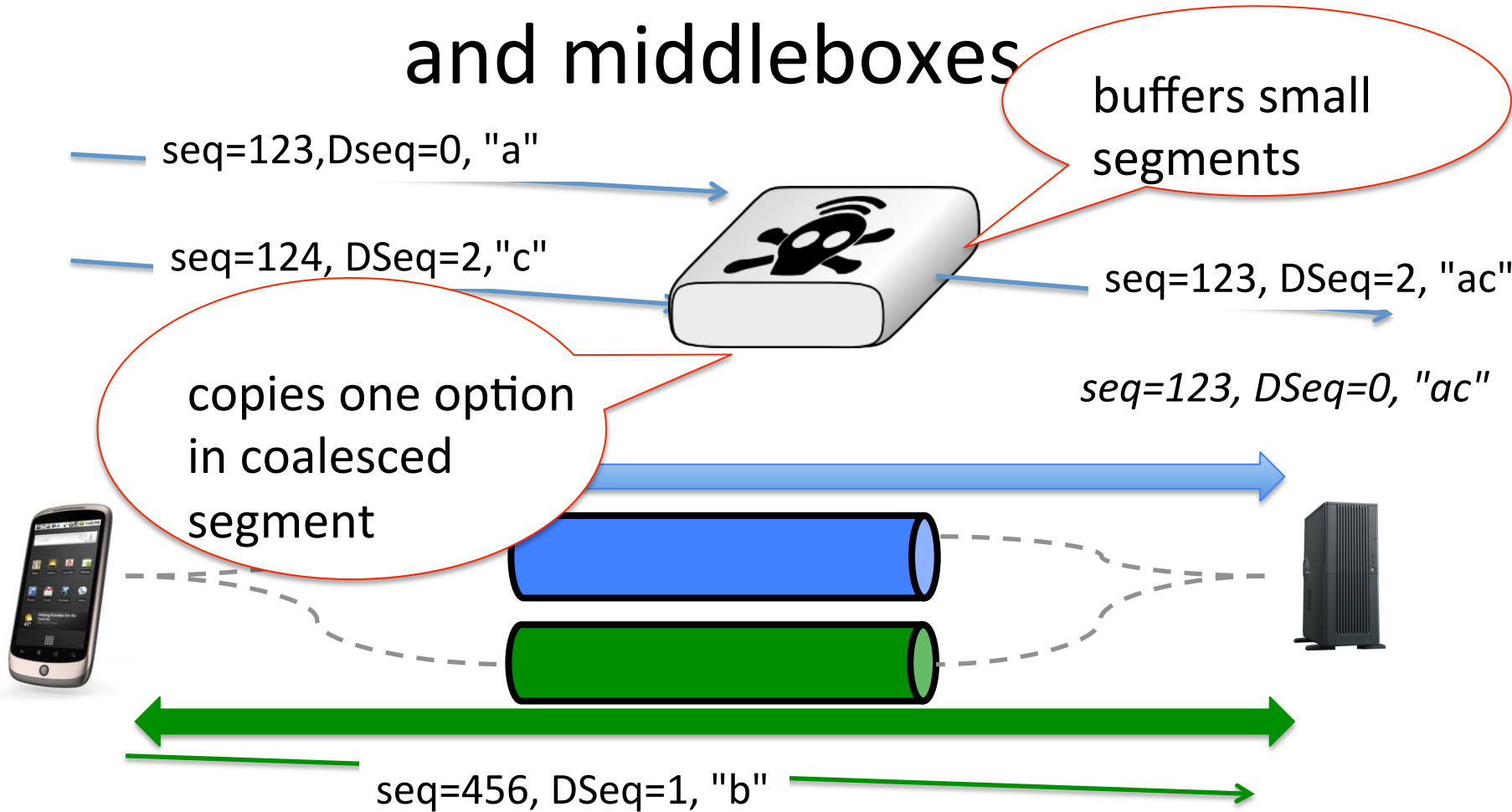

Data sequence numbers and middleboxes

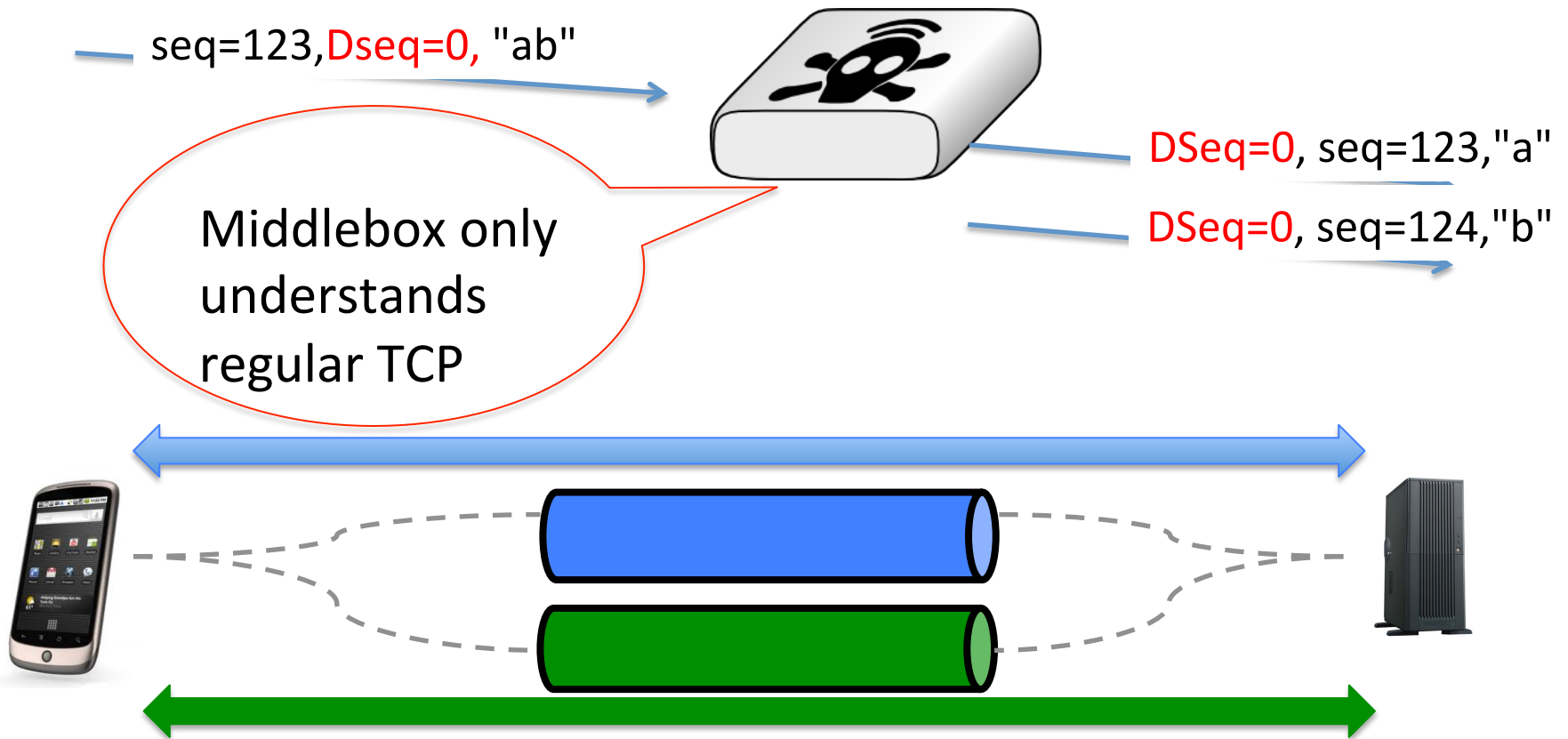

Data sequence numbers and middleboxes

- How to avoid desynchronisation between the bytestream and data sequence numbers ?
- Solution
 - Multipath TCP option carries **mapping** between Data sequence numbers and subflow sequence numbers
 - mapping covers a part of the bytestream (length)

Multipath TCP Data transfer

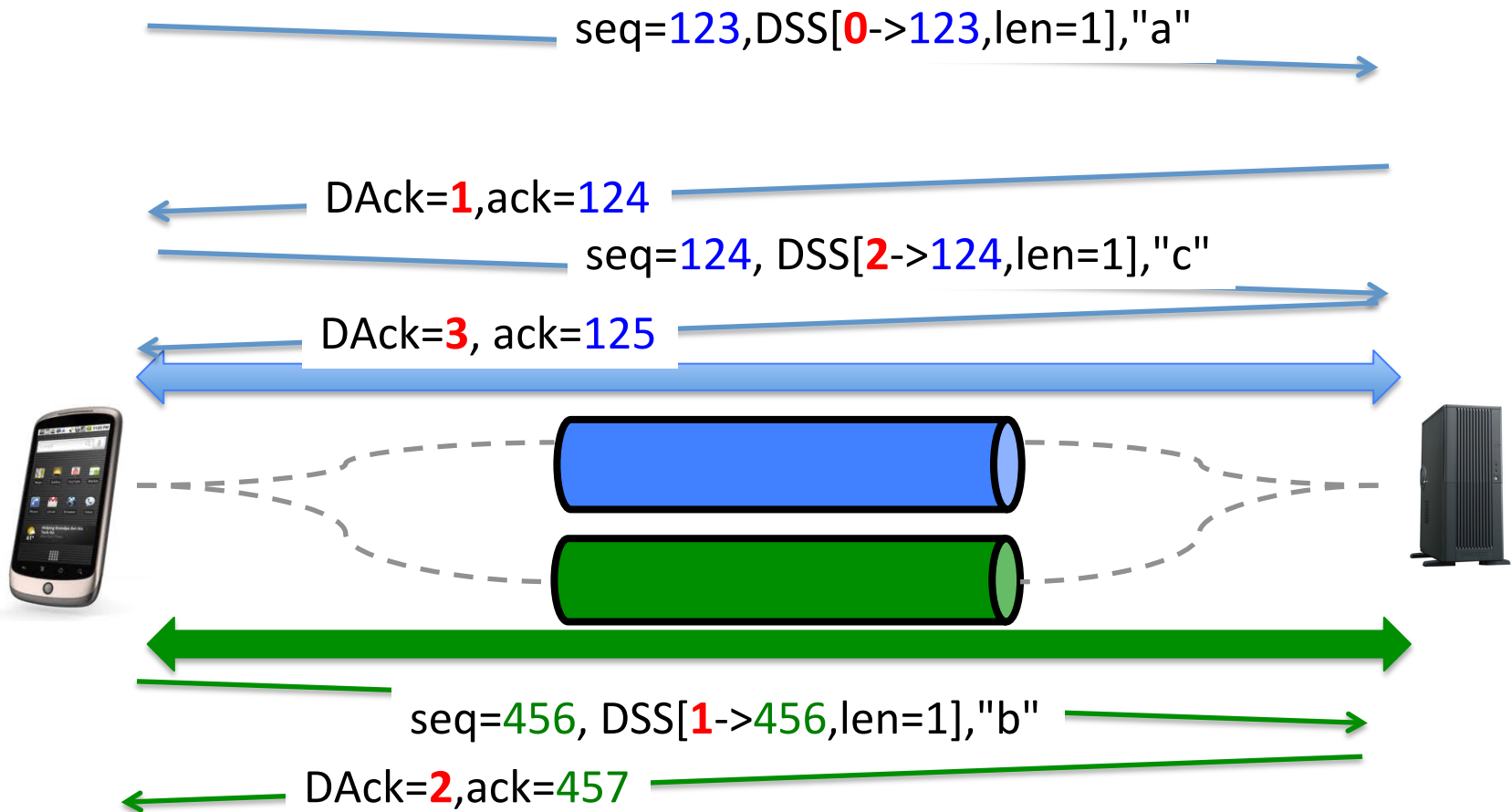

Data sequence numbers and middleboxes

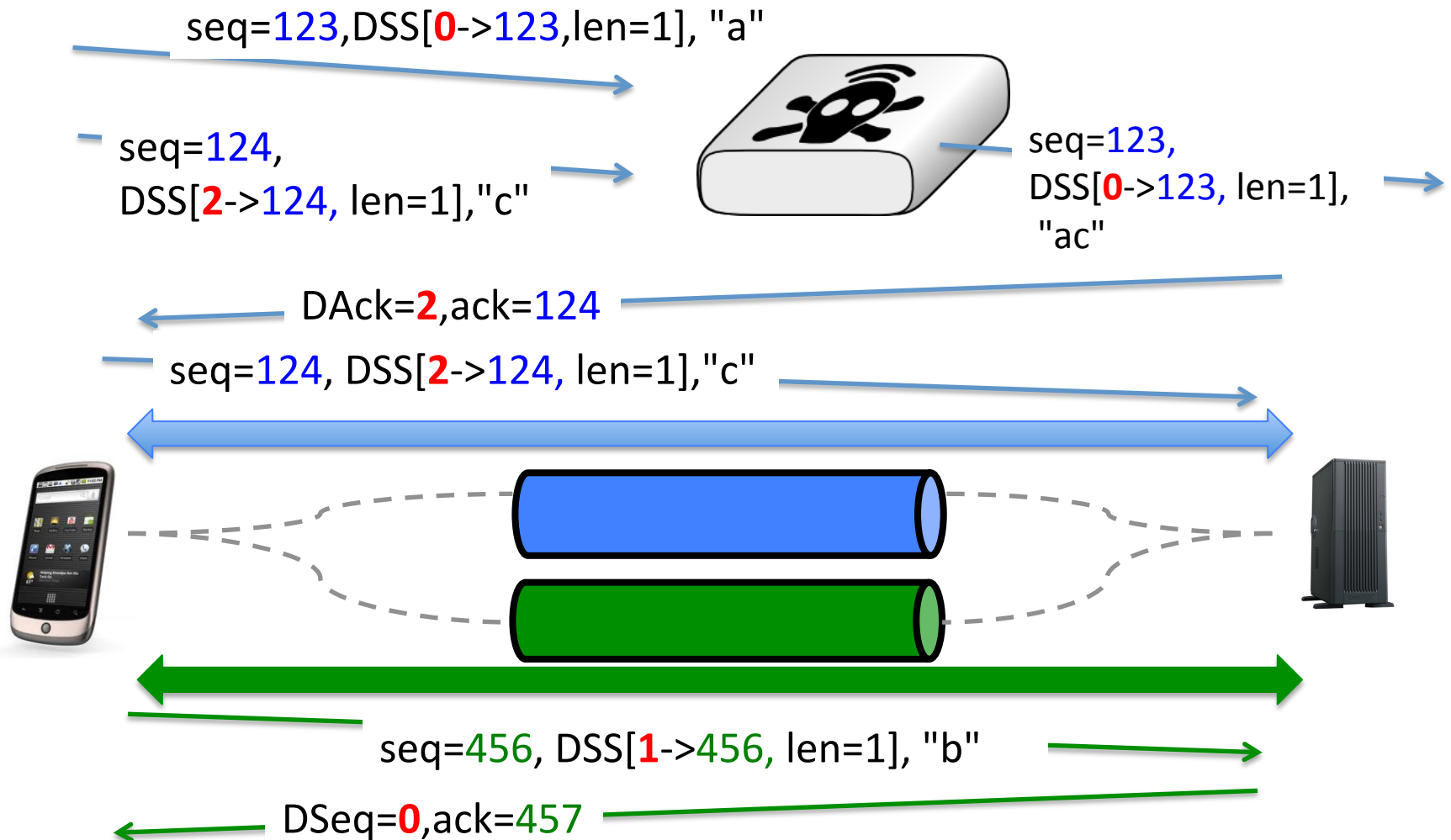

Data sequence numbers and middleboxes

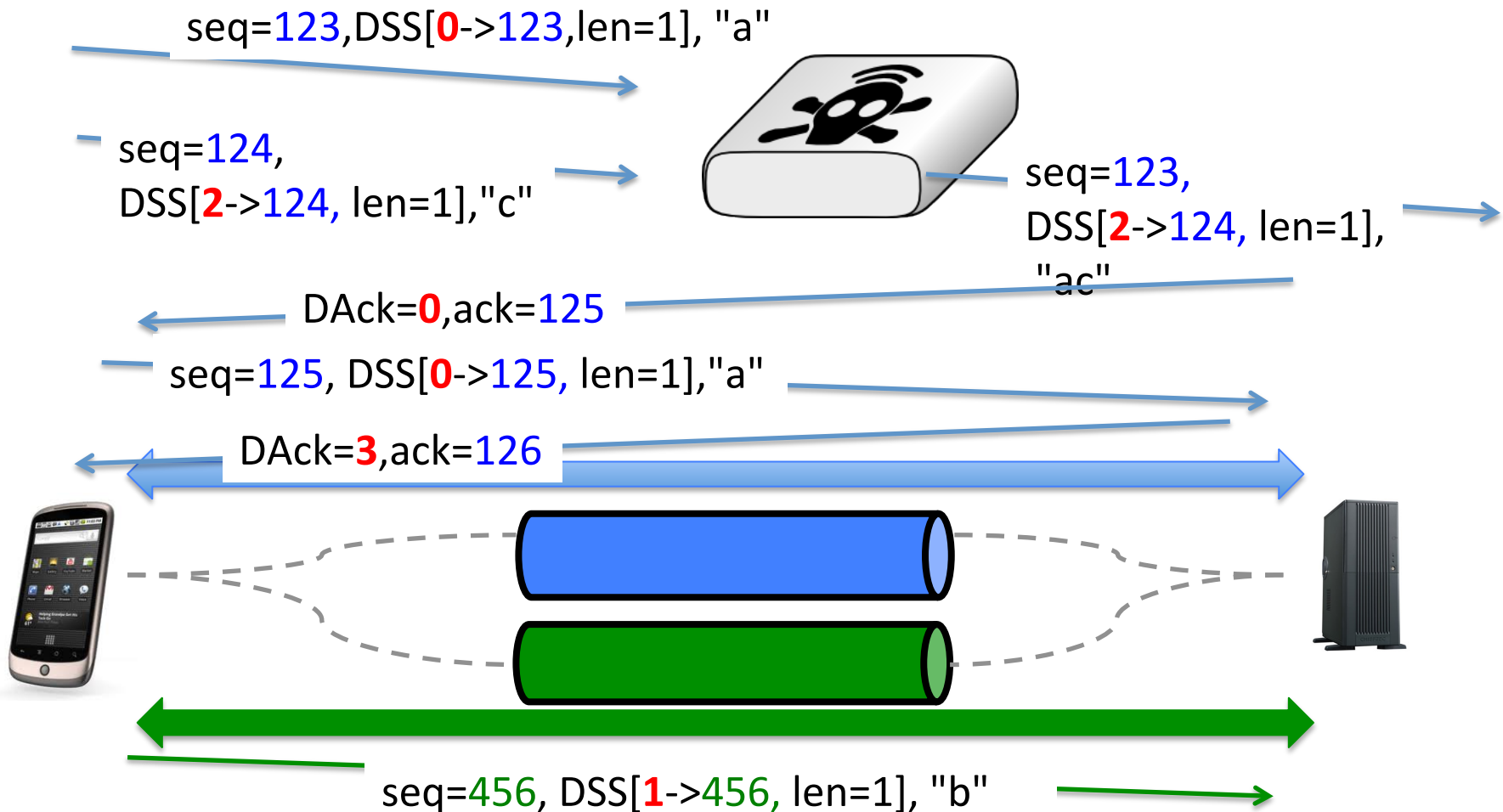

Multipath TCP and middleboxes

- With the DSS mapping, Multipath TCP can cope with middleboxes that
 - combine segments
 - split segments
- Are they the most annoying middleboxes for Multipath TCP ?
 - Unfortunately not

The worst middlebox

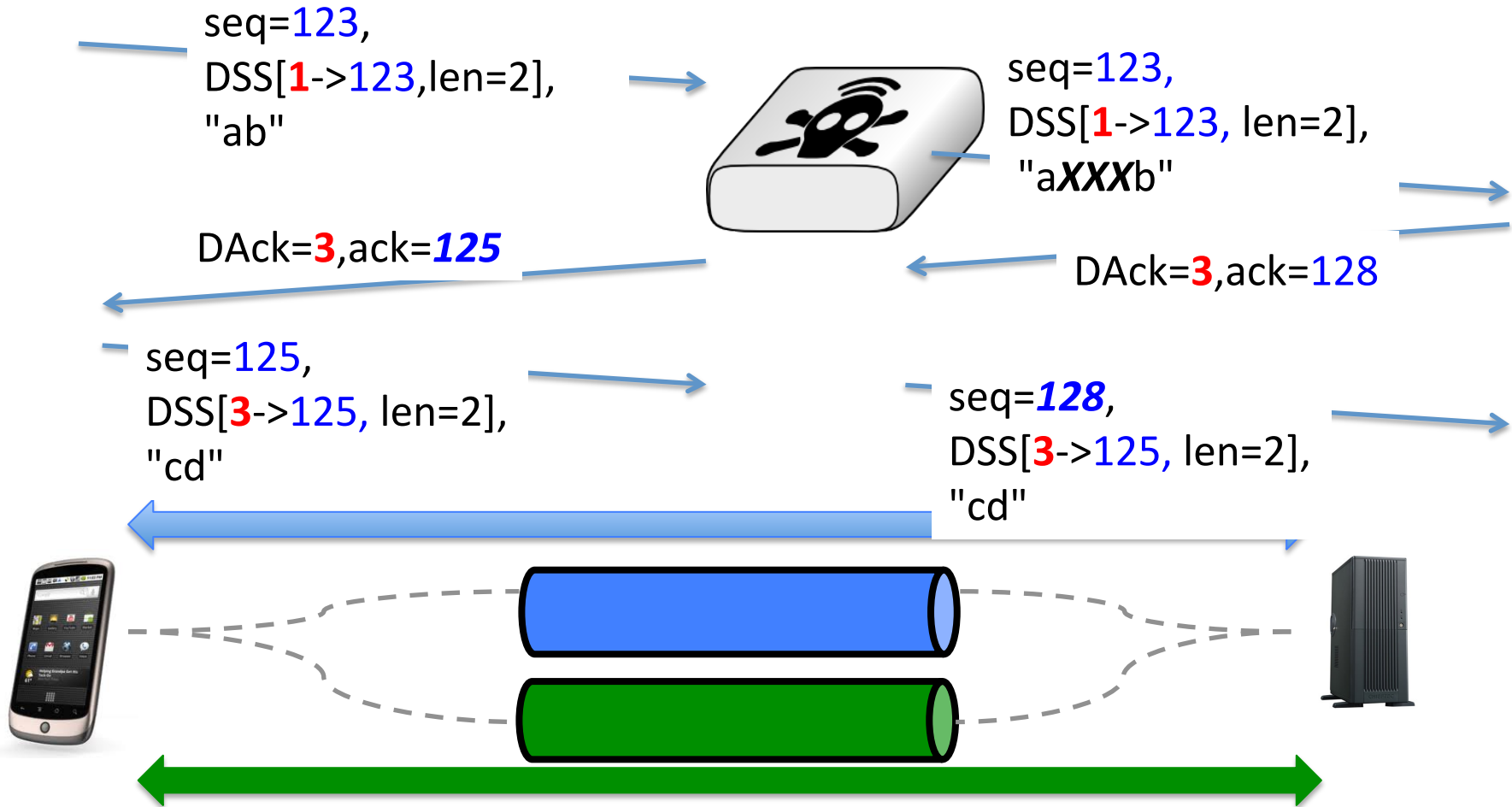

- Is this an academic exercise or reality ?

The worst middlebox

- Is unfortunately very old...
 - Any ALG for a NAT

```
220 ProFTPD 1.3.3d Server (BELNET FTPD Server) [193.190.67.15]
```

```
ftp_login: user '<null>' pass '<null>' host 'ftp.belnet.be'
```

```
Name (ftp.belnet.be:obo): anonymous
```

```
---> USER anonymous
```

```
331 Anonymous login ok, send your complete email address as your password
```

```
Password:
```

```
---> PASS XXXX
```

```
---> PORT 192,168,0,7,195,120
```

```
200 PORT command successful
```

```
---> LIST
```

```
150 Opening ASCII mode data connection for file list
```

```
lrw-r--r-- 1 ftp ftp 6 Jun 1 2011 pub -> mirror
```

```
226 Transfer complete
```

Coping with the worst middlebox

- What should Multipath TCP do in the presence of such a worst middlebox ?
 - Do nothing and ignore the middlebox
 - but then the bytestream and the application would be broken and this problem will be difficult to debug by network administrators
-  – Detect the presence of the middlebox
 - and fallback to regular TCP (i.e. use a single path and nothing fancy)

Detecting the worst middlebox ?

- How can Multipath TCP detect a middlebox that modifies the bytestream and inserts/removes bytes ?
 - Various options were explored
 - In the end, Multipath TCP chose to include its own checksum to detect insertion/deletion of bytes

The worst middlebox

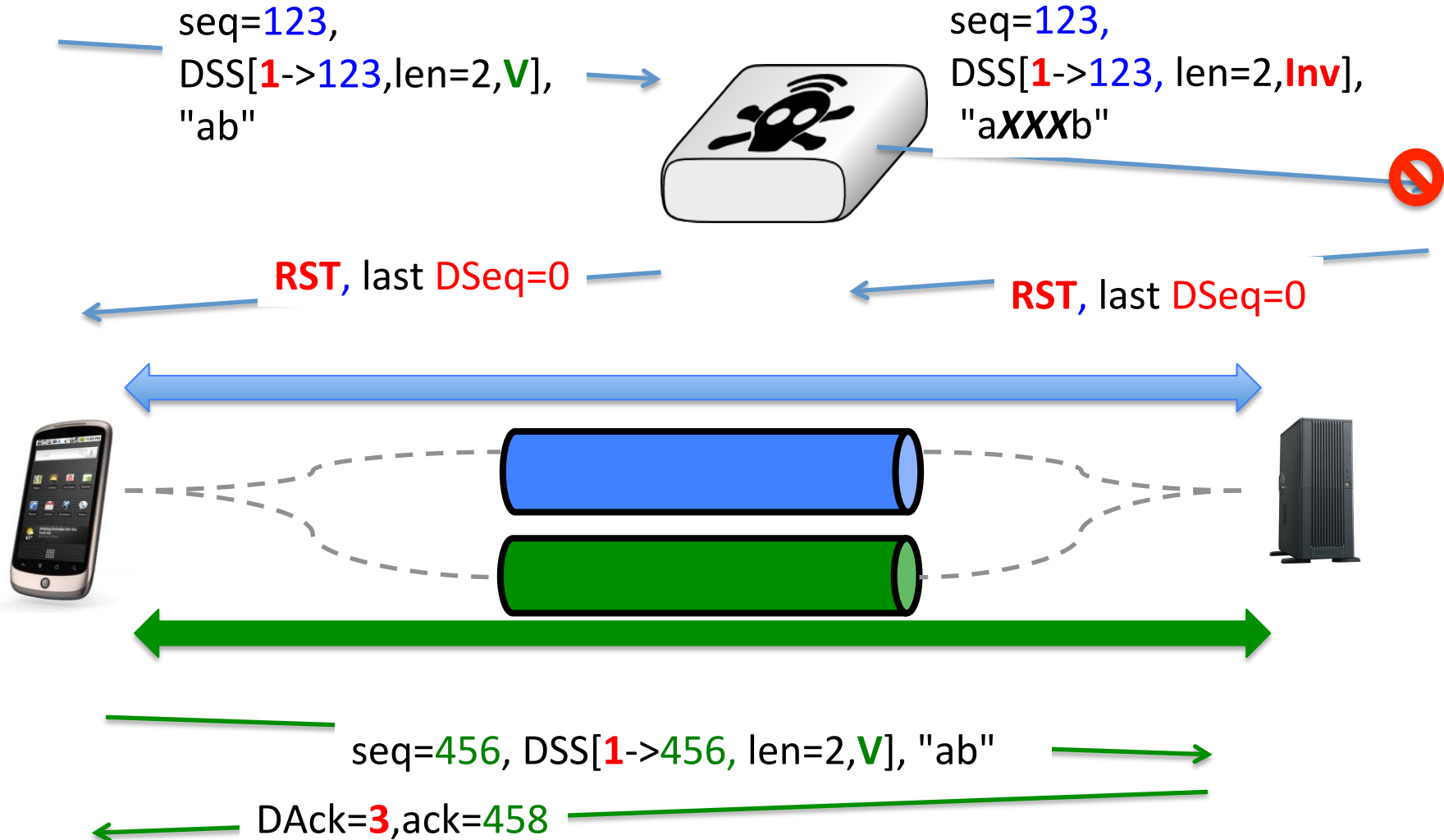

Multipath TCP

Data sequence numbers

- What should be the length of the data sequence numbers ?
 - 32 bits
 - compact and compatible with TCP
 - wrap around problem at highspeed requires PAWS
 - 64 bits
 - wrap around is not an issue for most transfers today
 - takes more space inside each segment

Multipath TCP

Data sequence numbers

- Data sequence numbers and Data acknowledgements
 - Maintained as 64 bits field
 - Implementations can, as an optimisation, only transmit the lower 32 bits of the data sequence and acknowledgements

Data Sequence Signal option

A = Data ACK present
 a = Data ACK is 8 octets
 M = mapping present
 m = DSN is 8

Cumulative Data ack

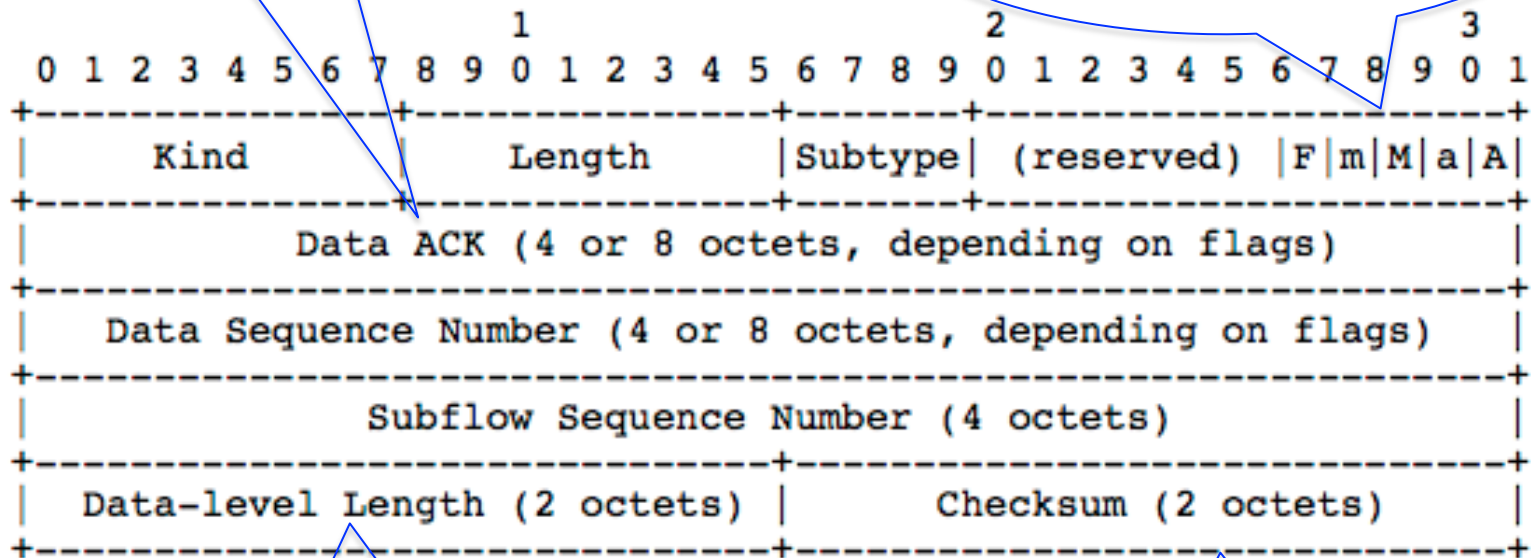

Length of mapping, can extend beyond this segment

Computed over data covered by **entire mapping** + pseudo header

Cost of the DSN checksum

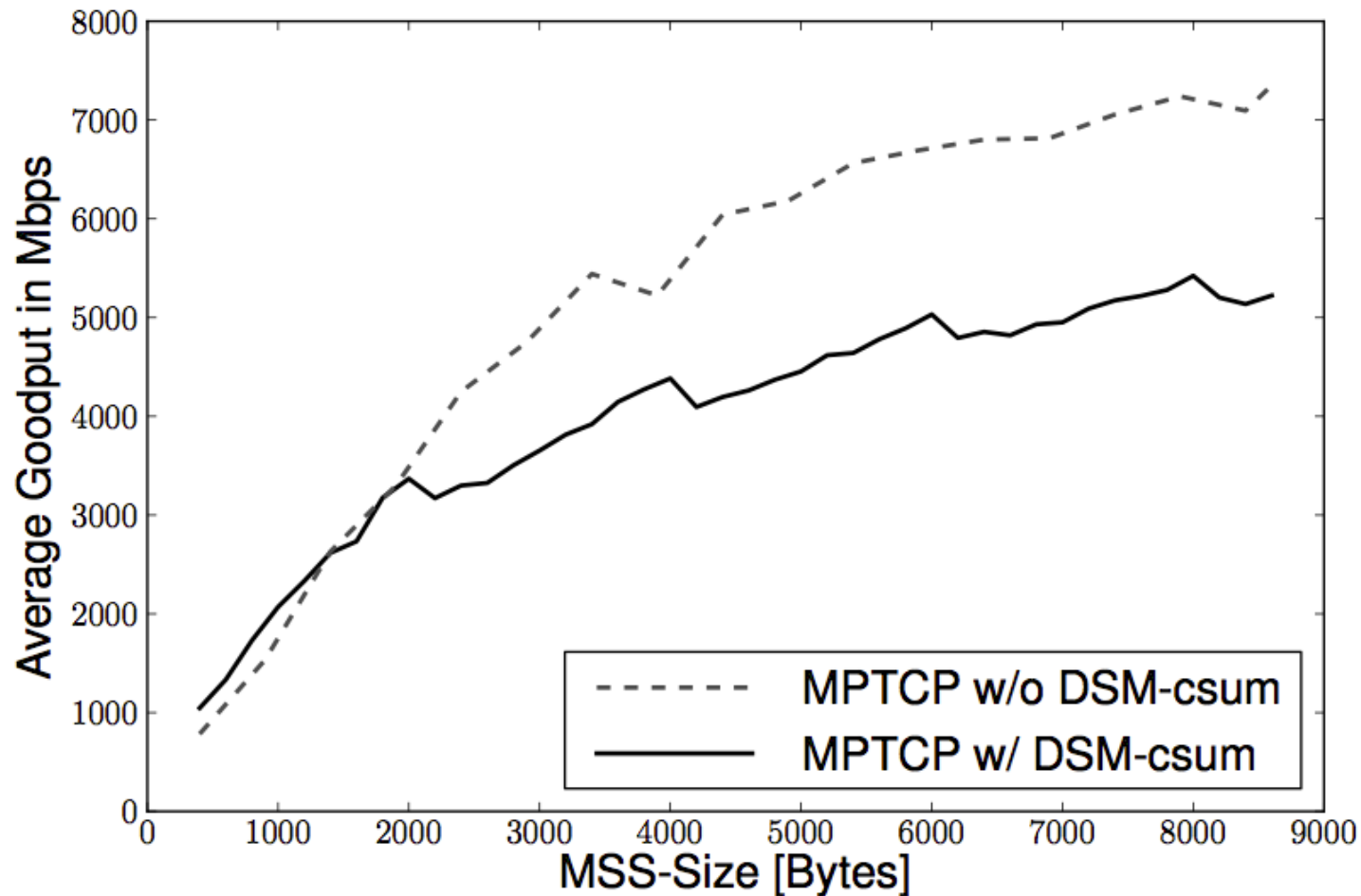

C. Raiciu, et al. "How hard can it be? designing and implementing a deployable multipath TCP," NSDI'12: Proceedings of the 9th USENIX conference on Networked Systems Design and Implementation, 2012.

The Multipath TCP protocol

- Control plane
 - How to manage a Multipath TCP connection that uses several paths ?
- Data plane
 - How to transport data ?

Congestion control

- How to control congestion over multiple paths ?

TCP congestion control

- A linear rate adaption algorithm
 - $rate(t + 1) = \alpha_C + \beta_C rate(t)$ when the network is congested
 - $rate(t + 1) = \alpha_N + \beta_N rate(t)$ when the network is *not* congested

To be fair and efficient, a linear algorithm must use additive increase and multiplicative decrease (AIMD)

```
# Additive Increase Multiplicative Decrease
if congestion :
    rate=rate*betaC      # multiplicative decrease, betaC<1
else
    rate=rate+alphaN    # additive increase, v0>0
```

AIMD in TCP

- Congestion control mechanism
 - Each host maintains a *congestion window (cwnd)*
 - No congestion
 - Congestion avoidance (**additive increase**)
 - increase *cwnd* by one segment every round-trip-time
 - Congestion
 - TCP detects congestion by detecting losses
 - Mild congestion (fast retransmit – **multiplicative decrease**)
 - $cwnd = cwnd/2$ and restart congestion avoidance
 - Severe congestion (timeout)
 - $cwnd = 1$, set slow-start-threshold and restart slow-start

Evolution of the congestion window

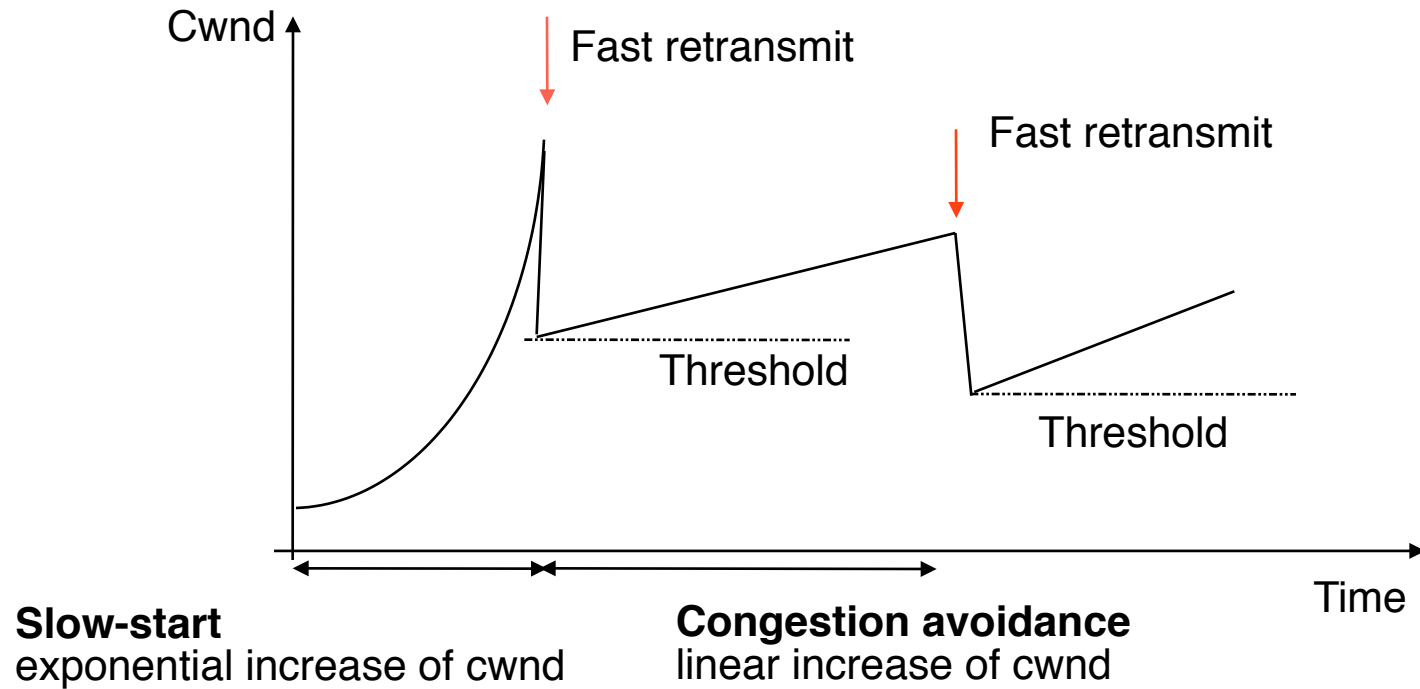

Congestion control for Multipath TCP

- Simple approach
 - independant congestion windows

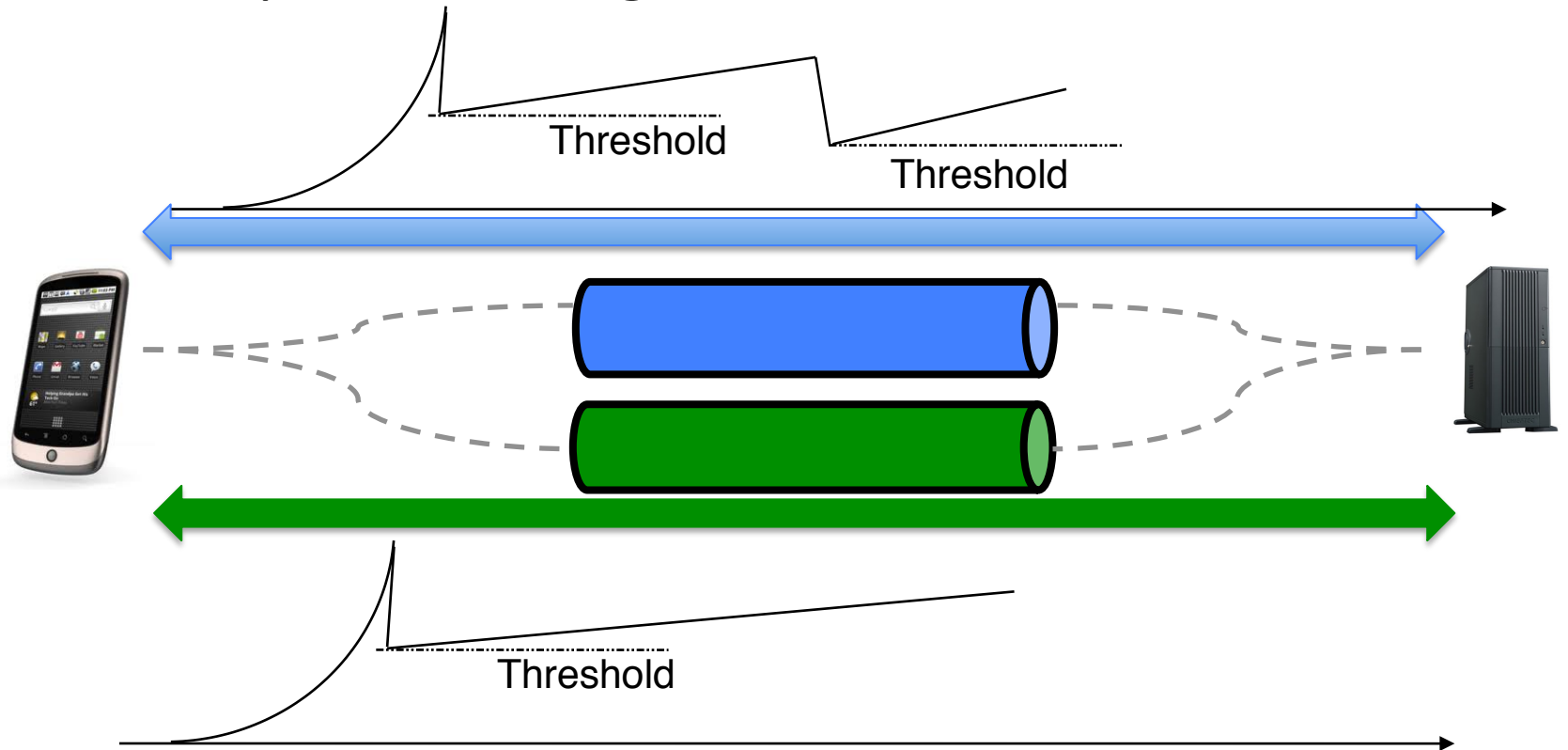

Independant congestion windows

- Problem

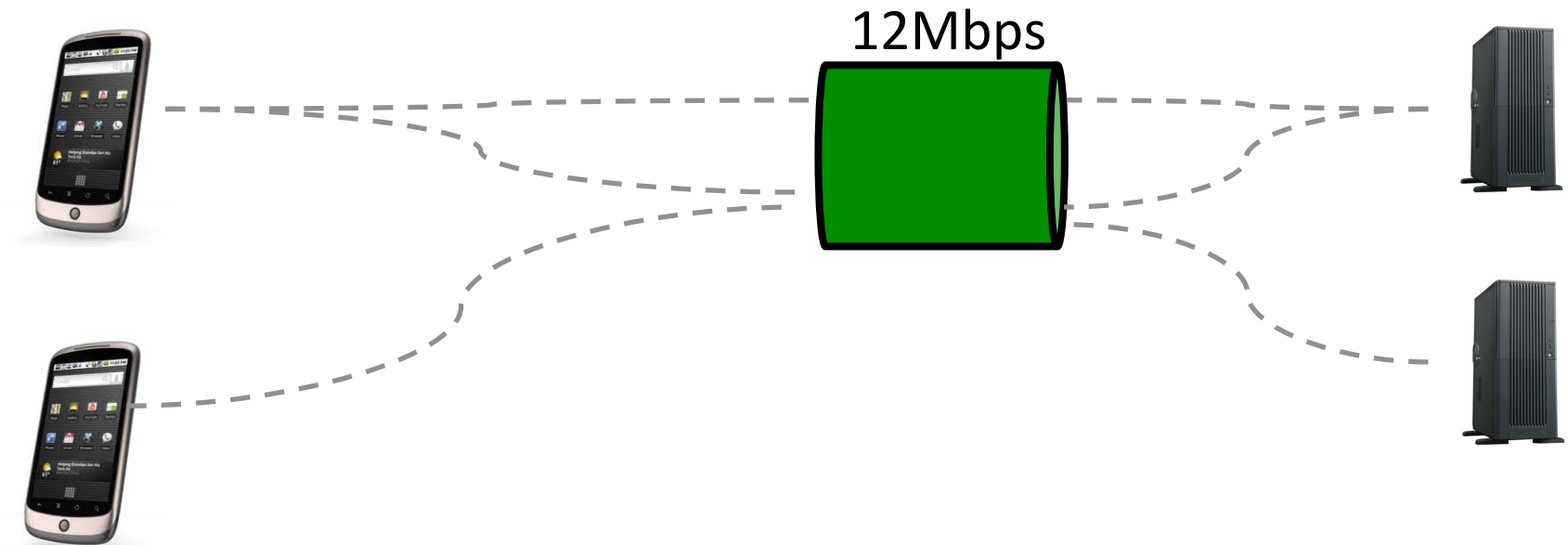

Coupling the congestion windows

- Principle
 - The TCP subflows are not independent and their congestion windows must be coupled
- EWTCP
 - For each ACK on path r , $cwin_r = cwin_r + a/cwin_r$ (in segments)
 - For each loss on path r , $cwin_r = cwin_r/2$
 - Each subflow gets window size proportional to a^2
 - Same throughput as TCP if
$$a = \frac{1}{\sqrt{n}}$$

Can we split traffic equally among all subflows ?

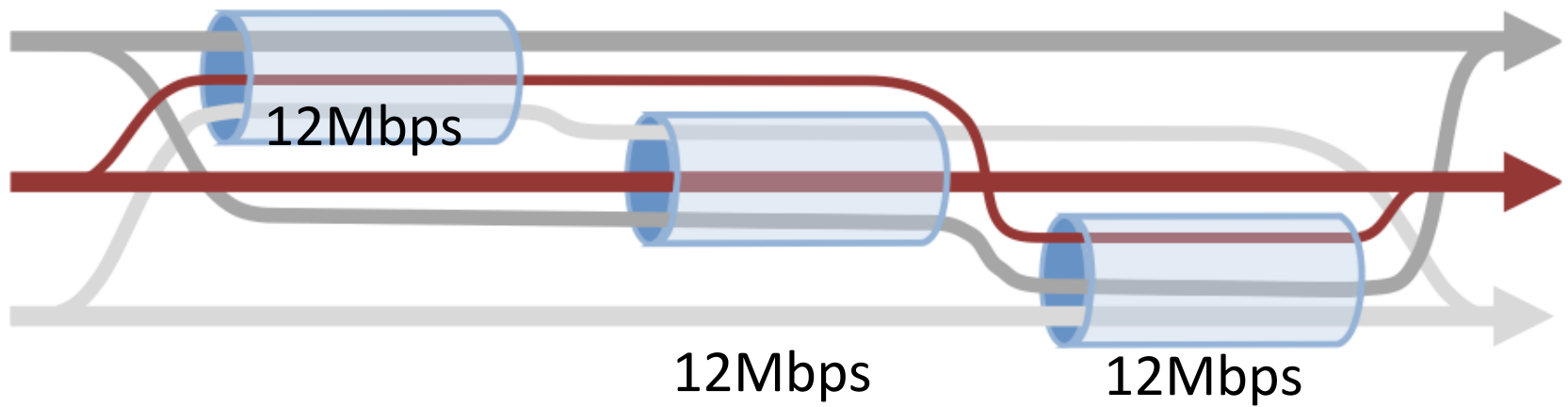

In this scenario, EWTCP would get 3.5 Mbps on the two hops path and 5 Mbps on the one hop path, less than the optimum of 12 Mbps for each Multipath TCP connection

Linked increases congestion control

- Algorithm

- For each loss on path r , $cwin_r = cwin_r / 2$

- Additive increase

$$cwin_r = cwin_r + \min\left(\frac{\max\left(\frac{cwnd_i}{(rtt_i)^2}\right)}{\left(\sum_i \frac{cwnd_i}{rtt_i}\right)^2}, \frac{1}{cwnd_r}\right)$$

Other Multipath-aware congestion control schemes

R. Khalili, N. Gast, M. Popovic, U. Upadhyay, J.-Y. Le Boudec, MPTCP is not Pareto-optimal: Performance issues and a possible solution, Proc. ACM Conext 2012

Y. Cao, X. Mingwei, and X. Fu, “Delay-based Congestion Control for Multipath TCP,” ICNP2012, 2012.

T. A. Le, C. S. Hong, and E.-N. Huh, “Coordinated TCP Westwood congestion control for multiple paths over wireless networks,” ICOIN '12: Proceedings of the The International Conference on Information Network 2012, 2012, pp. 92–96.

T. A. Le, H. Rim, and C. S. Hong, “A Multipath Cubic TCP Congestion Control with Multipath Fast Recovery over High Bandwidth-Delay Product Networks,” *IEICE Transactions*, 2012.

T. Dreibholz, M. Becke, J. Pulinthanath, and E. P. Rathgeb, “Applying TCP-Friendly Congestion Control to Concurrent Multipath Transfer,” Advanced Information Networking and Applications (AINA), 2010 24th IEEE International Conference on, 2010, pp. 312–319.

The Multipath TCP protocol

Control plane

- How to manage a Multipath TCP connection that uses several paths ?
- Data plane
 - How to transport data ?
- Congestion control
 - How to control congestion over multiple paths ?

The Multipath TCP control plane

- Connection establishment in details
- Closing a Multipath TCP connection
- Address dynamics

Security threats

- Three main security threats were considered
 - flooding attack
 - man-in-the middle attack
 - hijacking attach

Security goal :
Multipath TCP should not be
worse than regular TCP

Hijacking attack

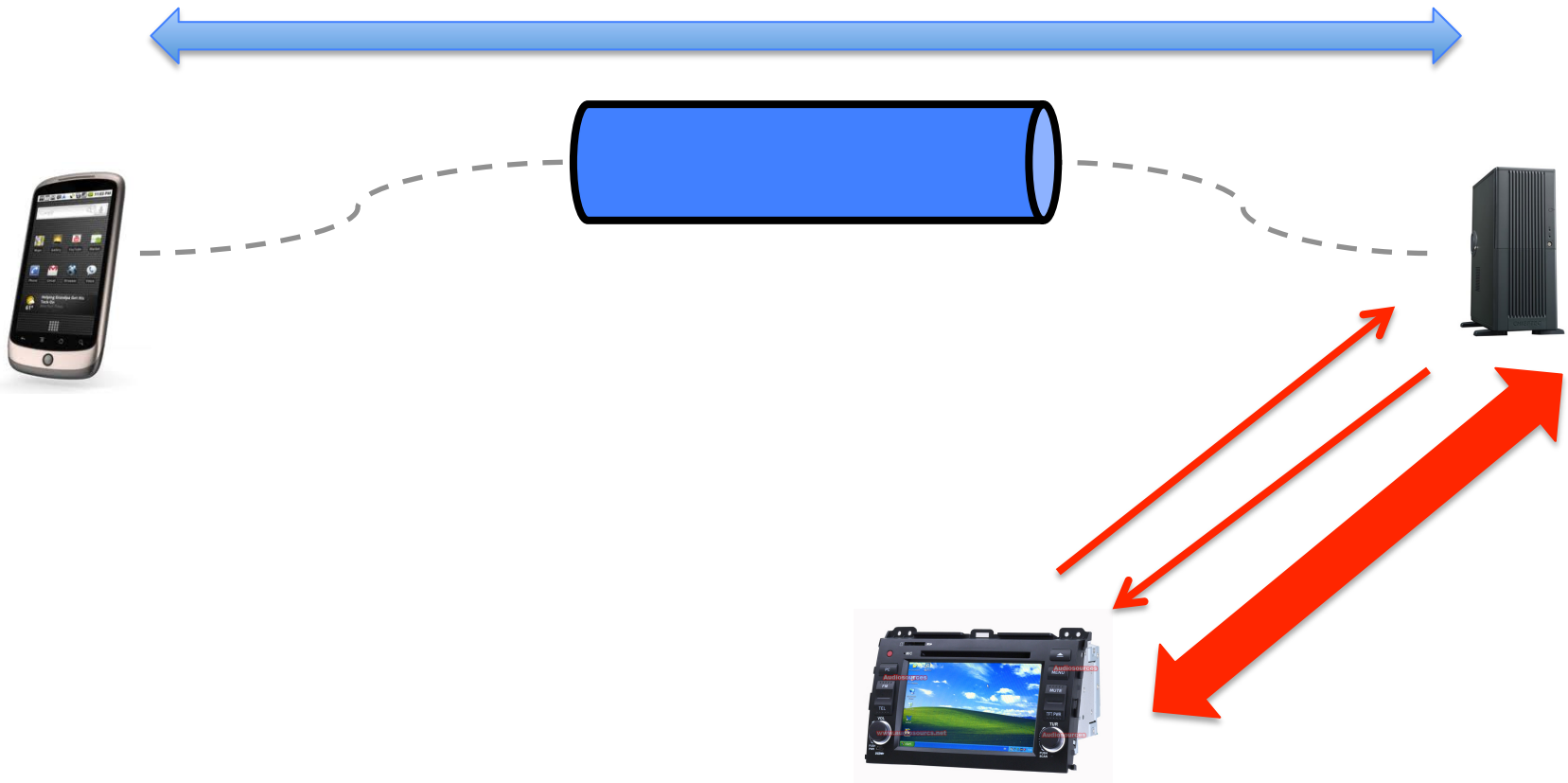

Multipath TCP

Connection establishment

- Principle

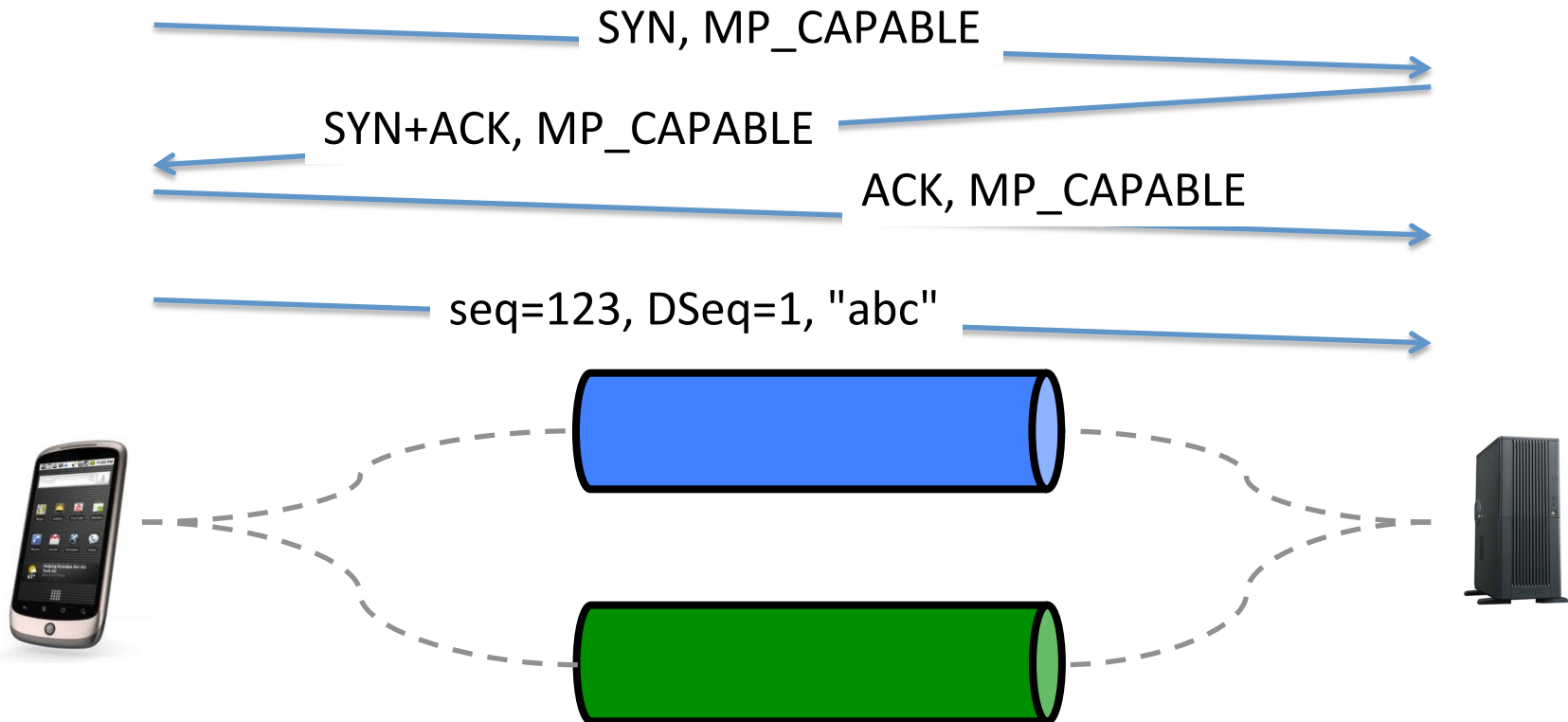

Roles of the initial TCP handshake

- Check willingness to open TCP connection
 - Propose initial sequence number
 - Negotiate Maximum Segment Size
- TCP options
 - negotiate Timestamps, SACK, Window scale
- Multipath TCP
 - check that server supports Multipath TCP
 - propose Token in each direction
 - propose initial Data sequence number in each direction
 - Exchange keys to authenticate subflows

How to extend TCP ?

Theory

- TCP options were invented for this purpose
 - Exemple SACK

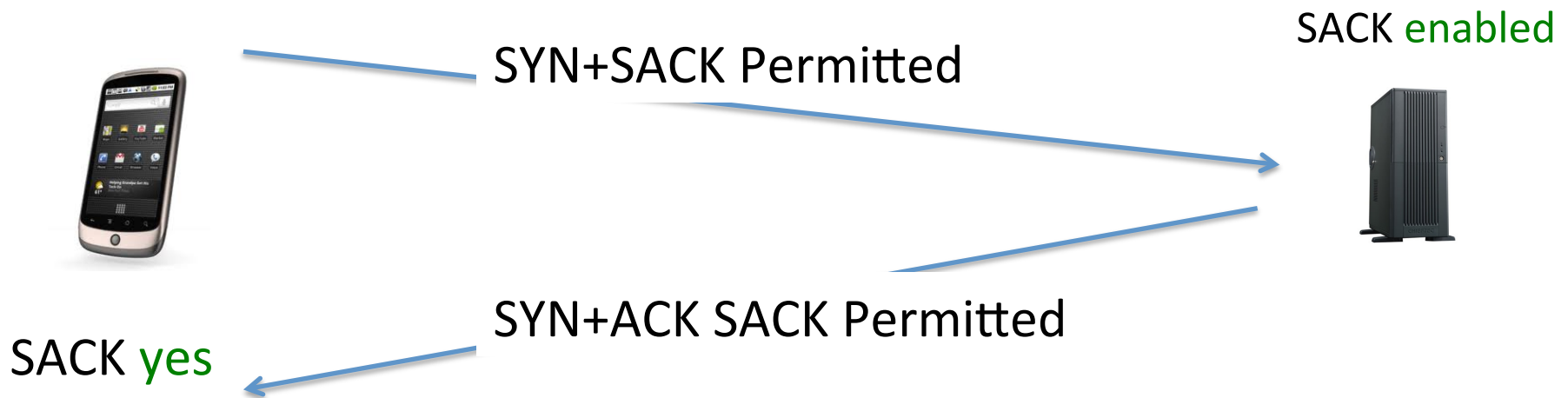

How to extend TCP ? practice

- What happens when there are middleboxes on the path ?

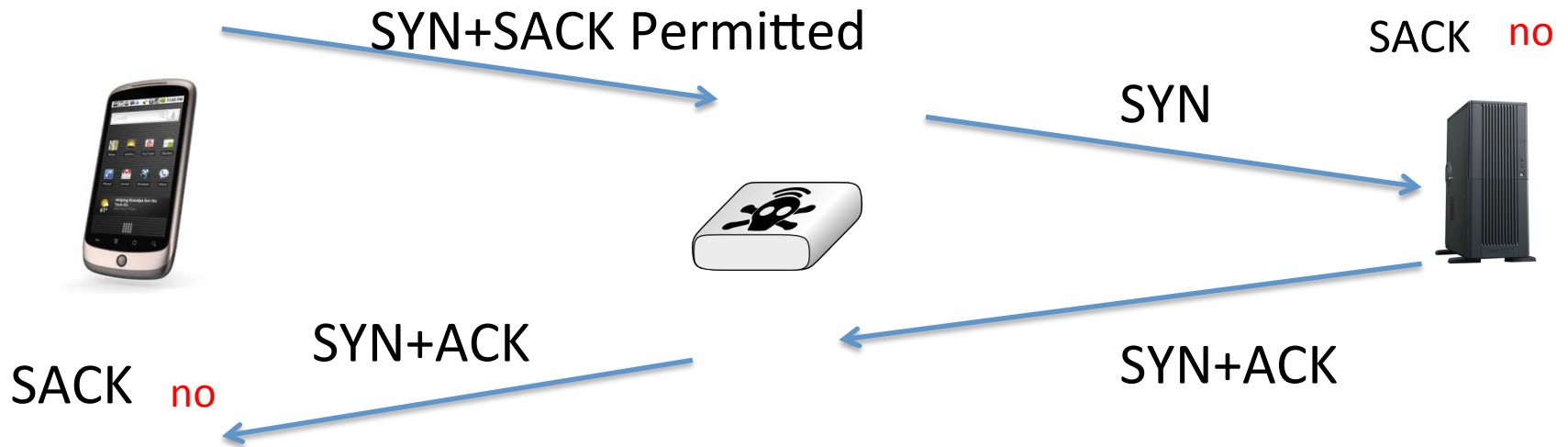

TCP options

- In SYN segments

SYN segments, port 34443

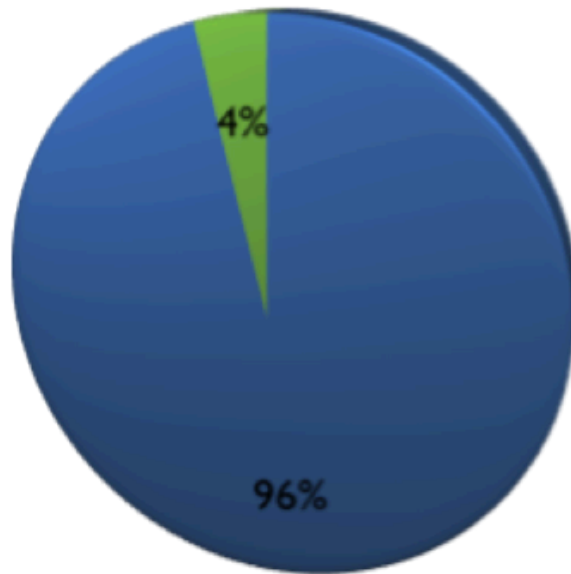

SYN segments, port 80

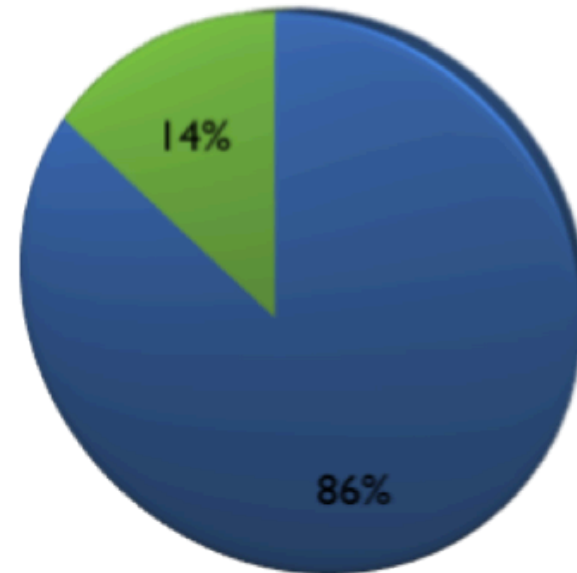

How to extend TCP ?

The worst case

- What happens when there are middleboxes on the path ?

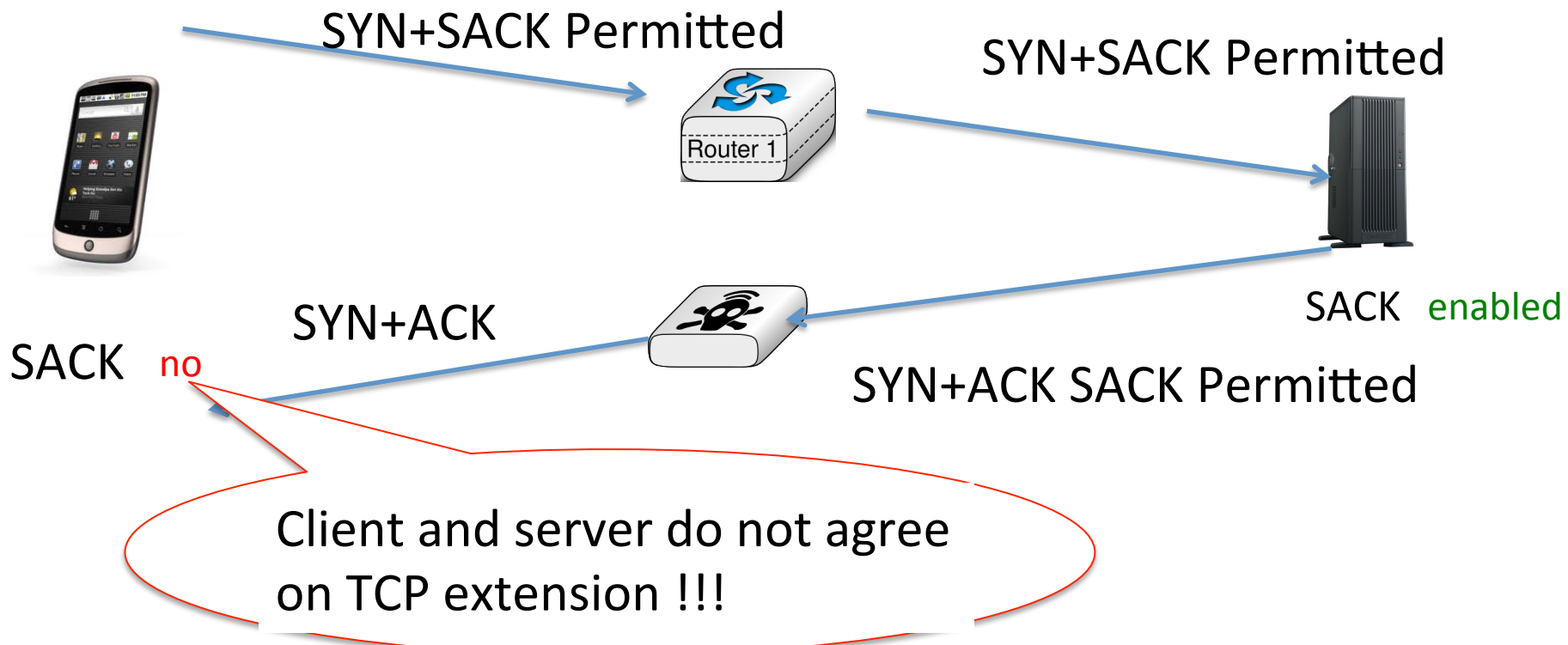

Multipath TCP handshake

Does server support Multipath TCP ?

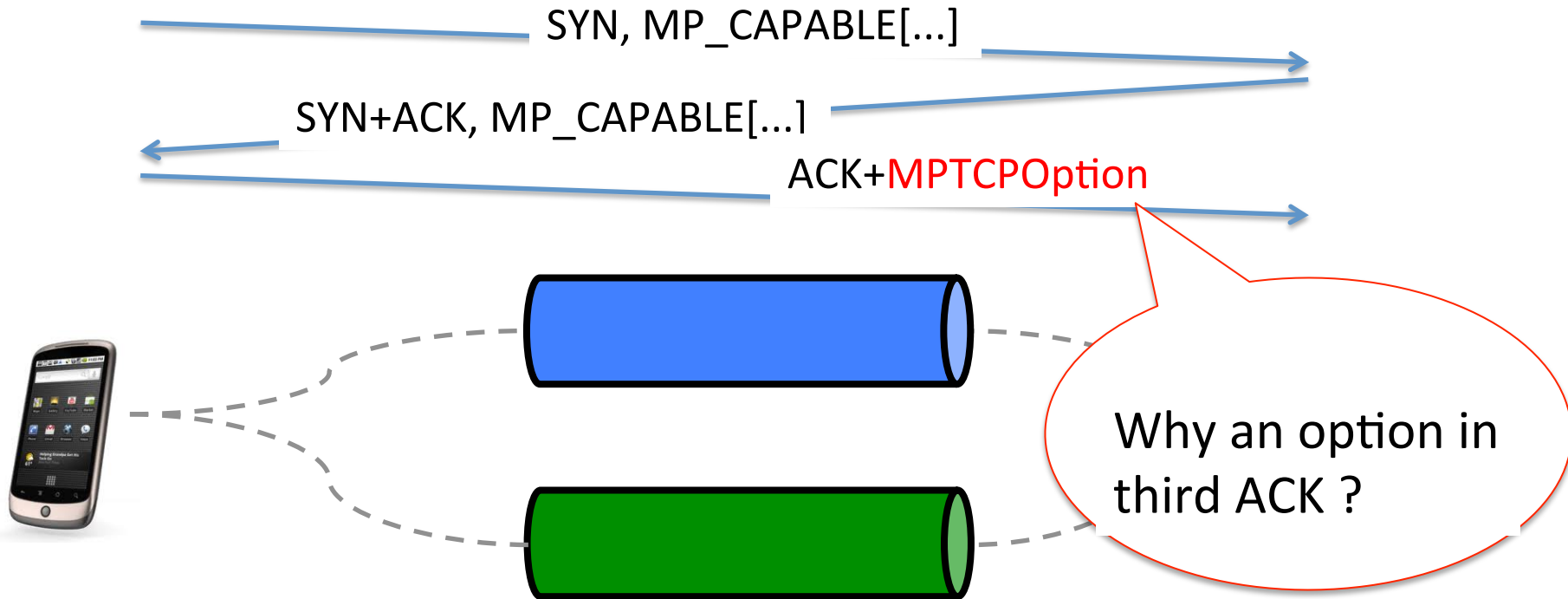

Multipath TCP option in third ACK

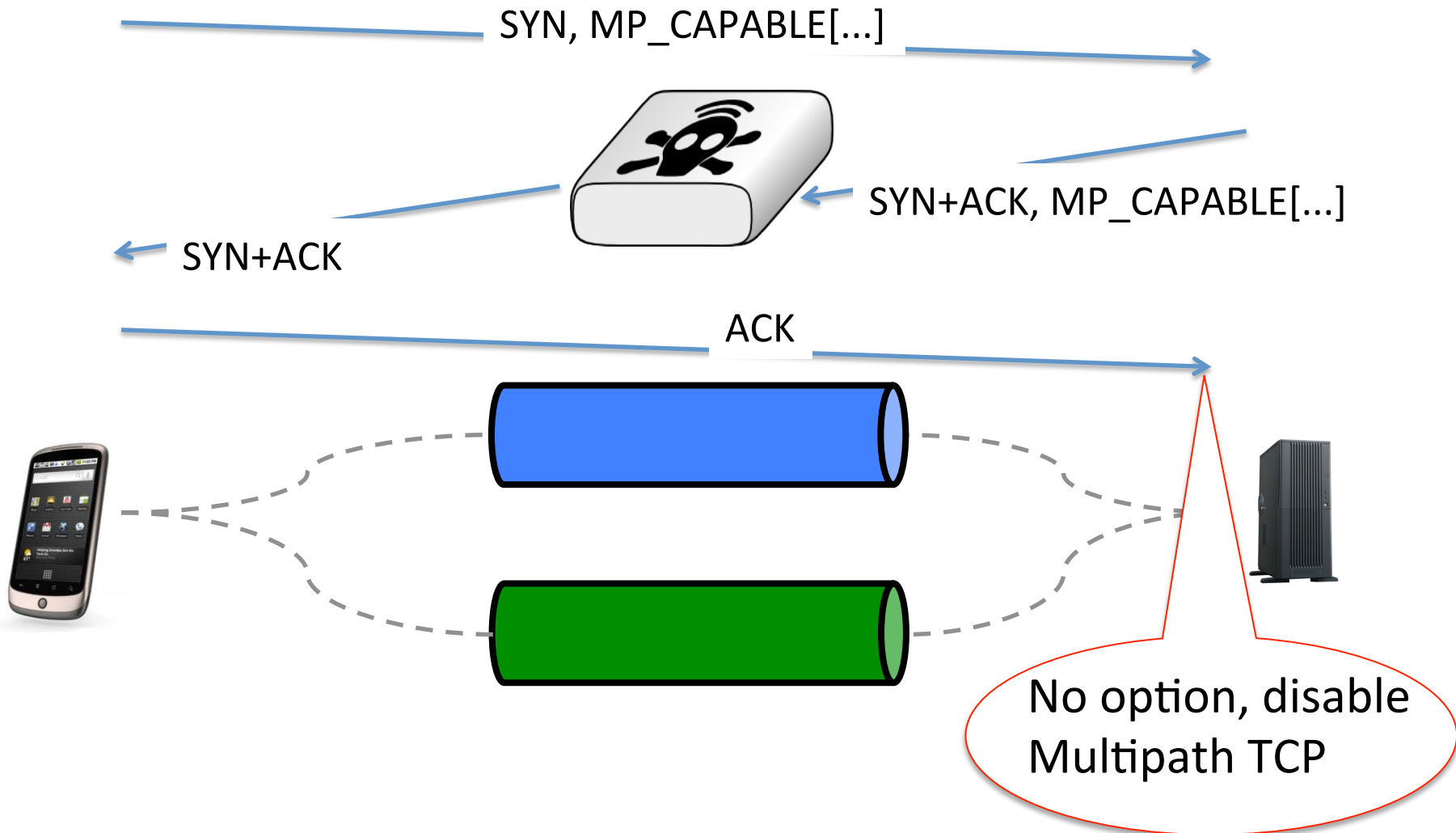

Multipath TCP handshake Token exchange

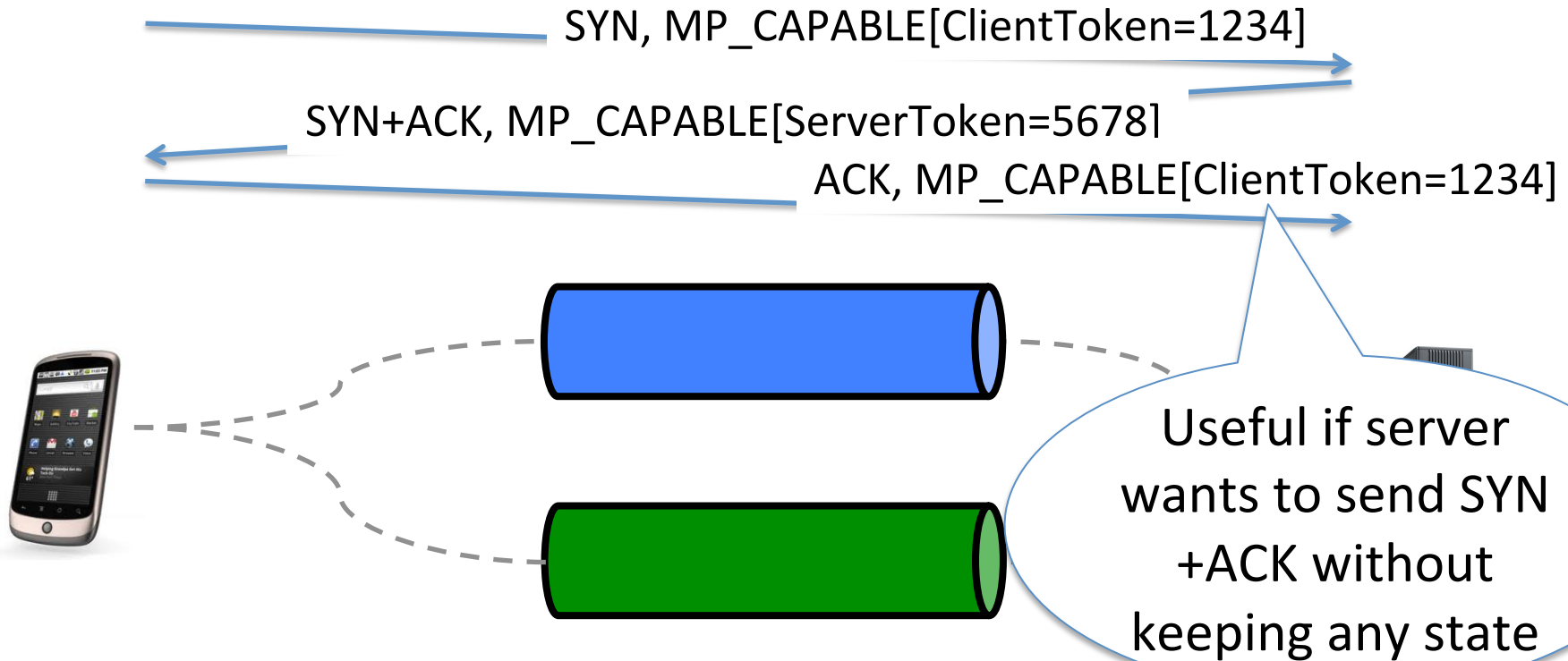

Initial Data Sequence number

- Why do we need an initial Data Sequence number ?
 - Setting IDSN to a random value improves security
 - Hosts must know IDSN to avoid losing data in some special cases

Initial Data Sequence number

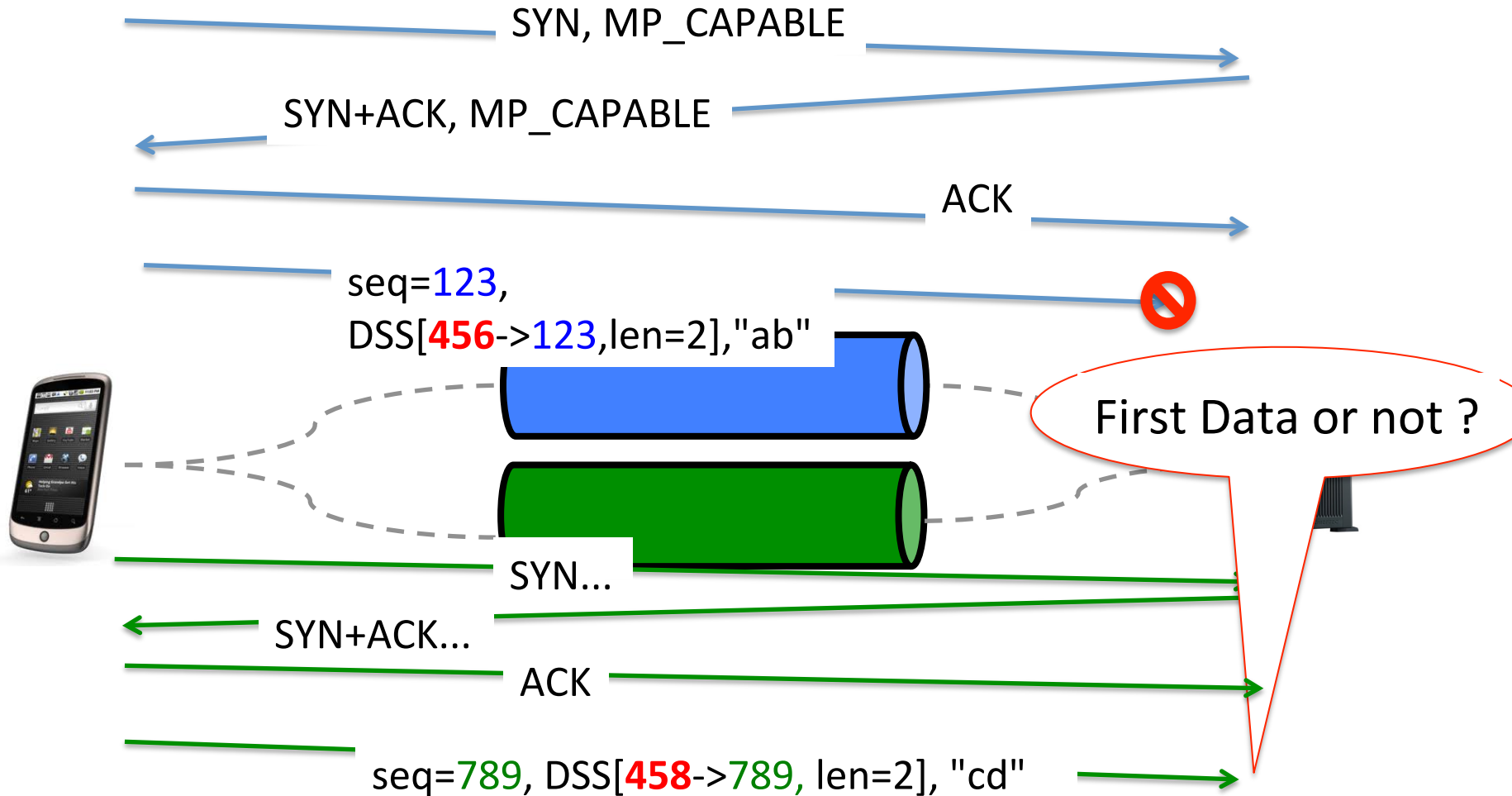

Initial Data Sequence number

- How to fix the IDSN ?

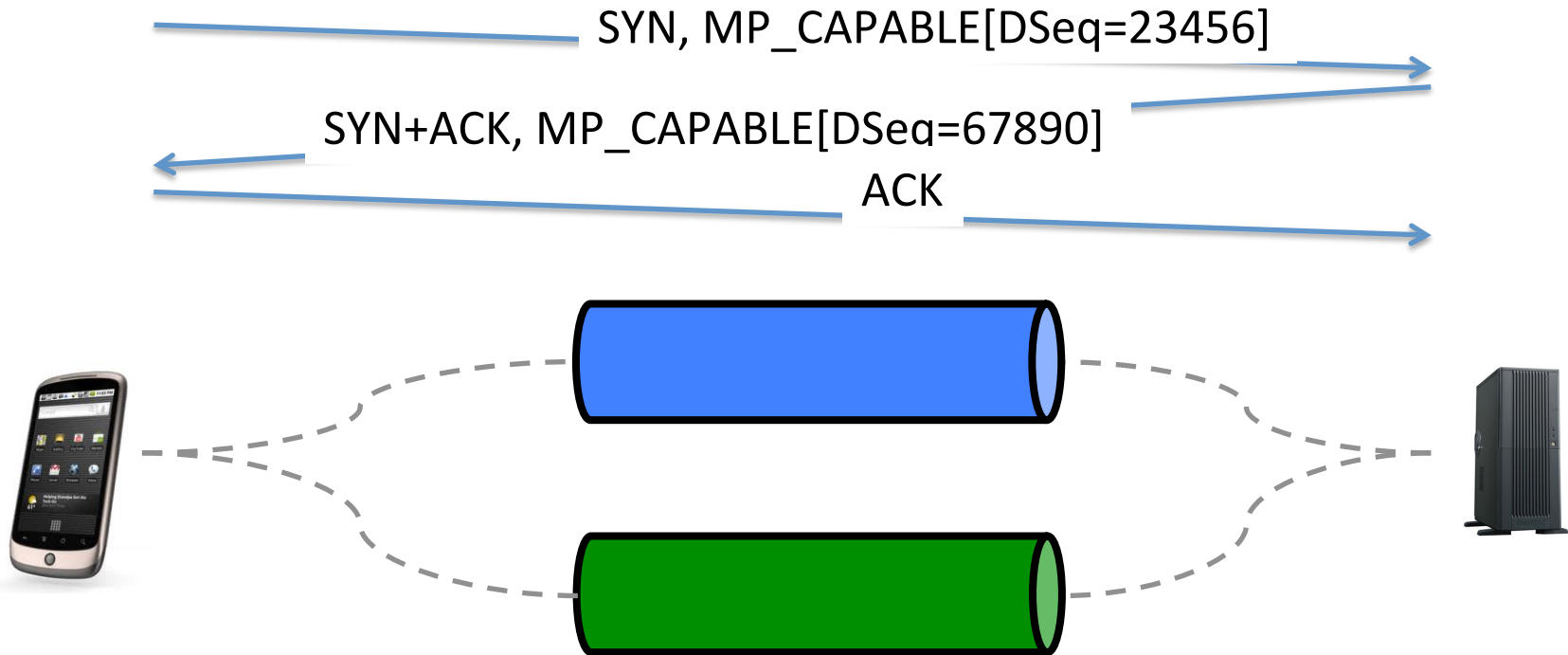

How to secure Multipath TCP

- Main goal
 - Authenticate the establishment of subflows
- Principles
 - Each host announces a key during initial handshake
 - keys are exchanged in clear
 - When establishing a subflow, use HMAC + key to authenticate subflow

Key exchange

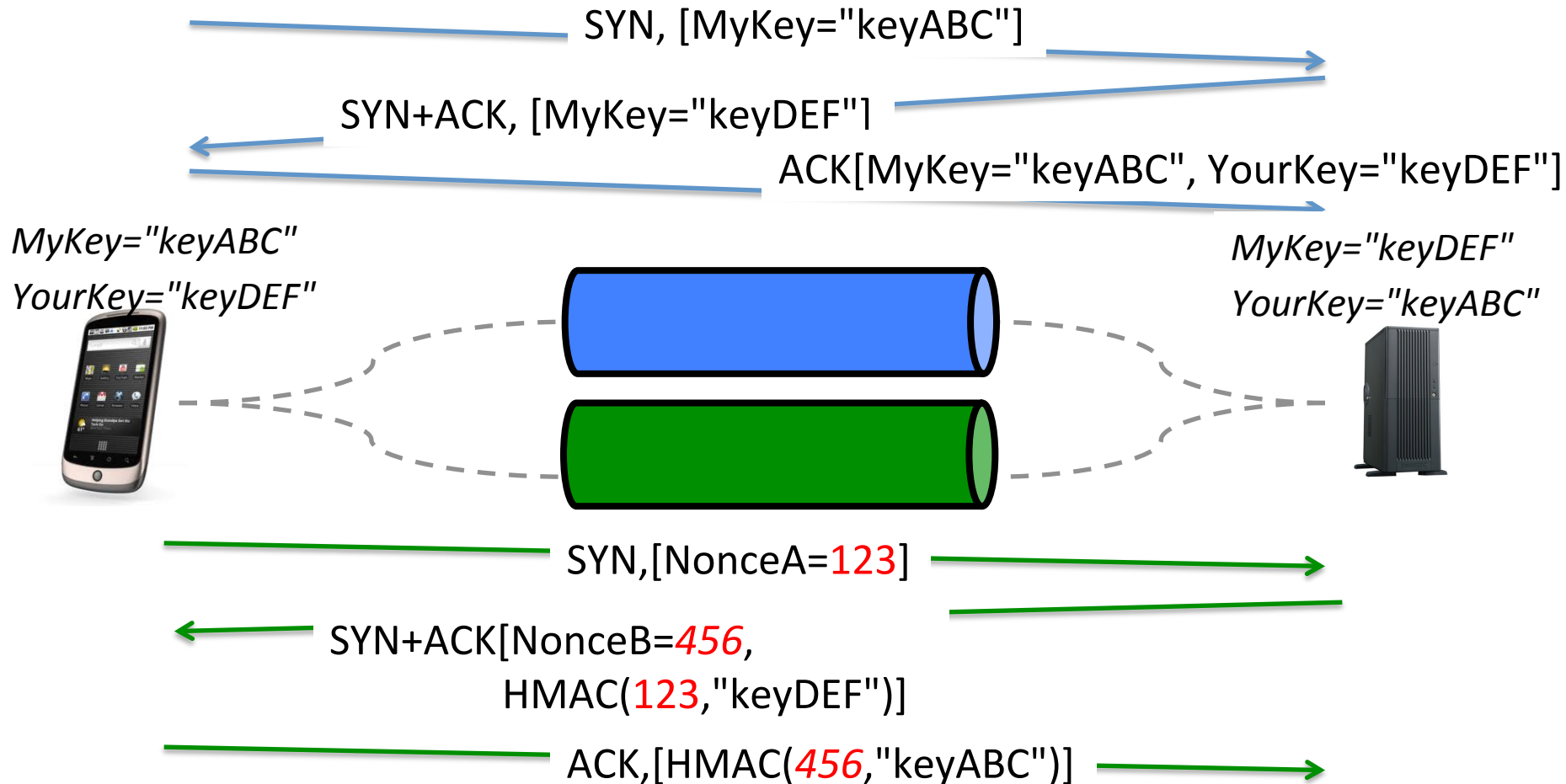

Putting everything inside the SYN

- How can we place inside the SYN segment
 - Initial Data Sequence Number (64 bits)
 - Token (32 bits)
 - Authentication Key (the longer the better)

Constraint on TCP options

Ver	IHL	ToS	Total length	
Identification		Flags	Frag. Offset	
TTL		Protocol	Checksum	
Source IP address				
Destination IP address				
Source port		Destination port		
Sequence number				
Acknowledgment number				
THL	Reserved	Flags	Window	
Checksum		Urgent pointer		
<i>Options</i>				
Payload				

- Total length of TCP header : max 64 bytes
 - max 44 bytes for TCP options
 - size must be multiple of 4 bytes

TCP options in the wild

- MSS option [4 bytes]
 - Used only inside SYN segments
- Timestamp option [10 bytes]
 - Used in potentially all segments
- Window scale option [3 bytes]
 - Used only inside SYN segments
- SACK permitted option [2 bytes]
 - Used only inside SYN segments
- Selective Acknowledgements [N bytes]
 - Used in data segments

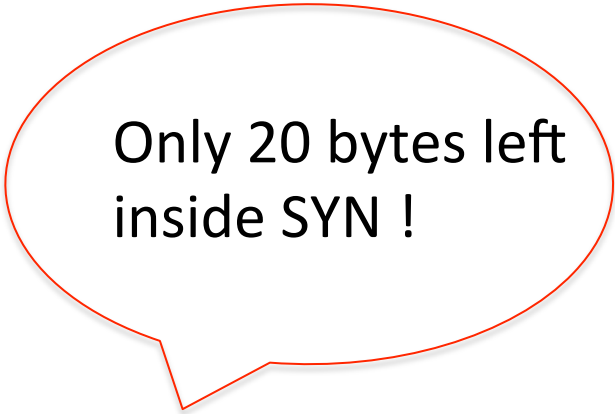

Only 20 bytes left
inside SYN !

The MP_CAPABLE option

A: DSN Checksum required or not

B: Extension

crypto

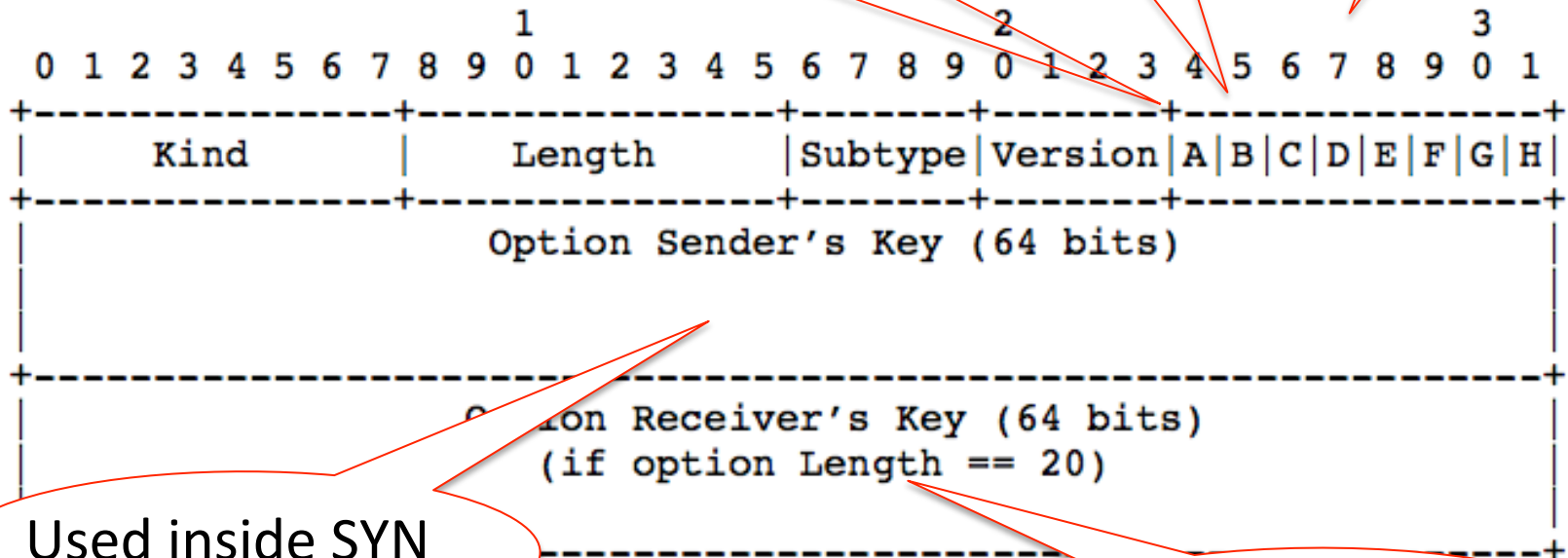

Used inside SYN

Only in third ACK

Initial Data Sequence Numbers and Tokens

- Where is the initial Data Sequence Number

$$\text{IDSN}_A = \text{Lower}_{64}(\text{SHA-1}(\text{Key}_A))$$

$$\text{IDSN}_B = \text{Lower}_{64}(\text{SHA-1}(\text{Key}_B))$$

- Where is the token ?

$$\text{Token}_A = \text{Upper}_{32}(\text{SHA-1}(\text{Key}_A))$$

$$\text{Token}_B = \text{Upper}_{32}(\text{SHA-1}(\text{Key}_B))$$

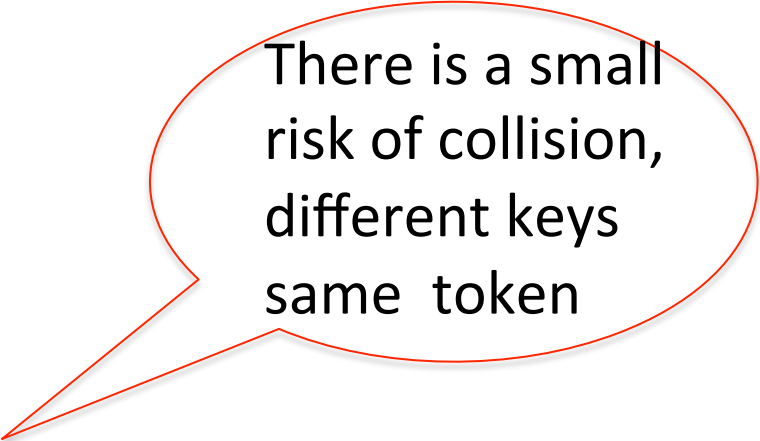

There is a small
risk of collision,
different keys
same token

Cost of the Multipath TCP handshake

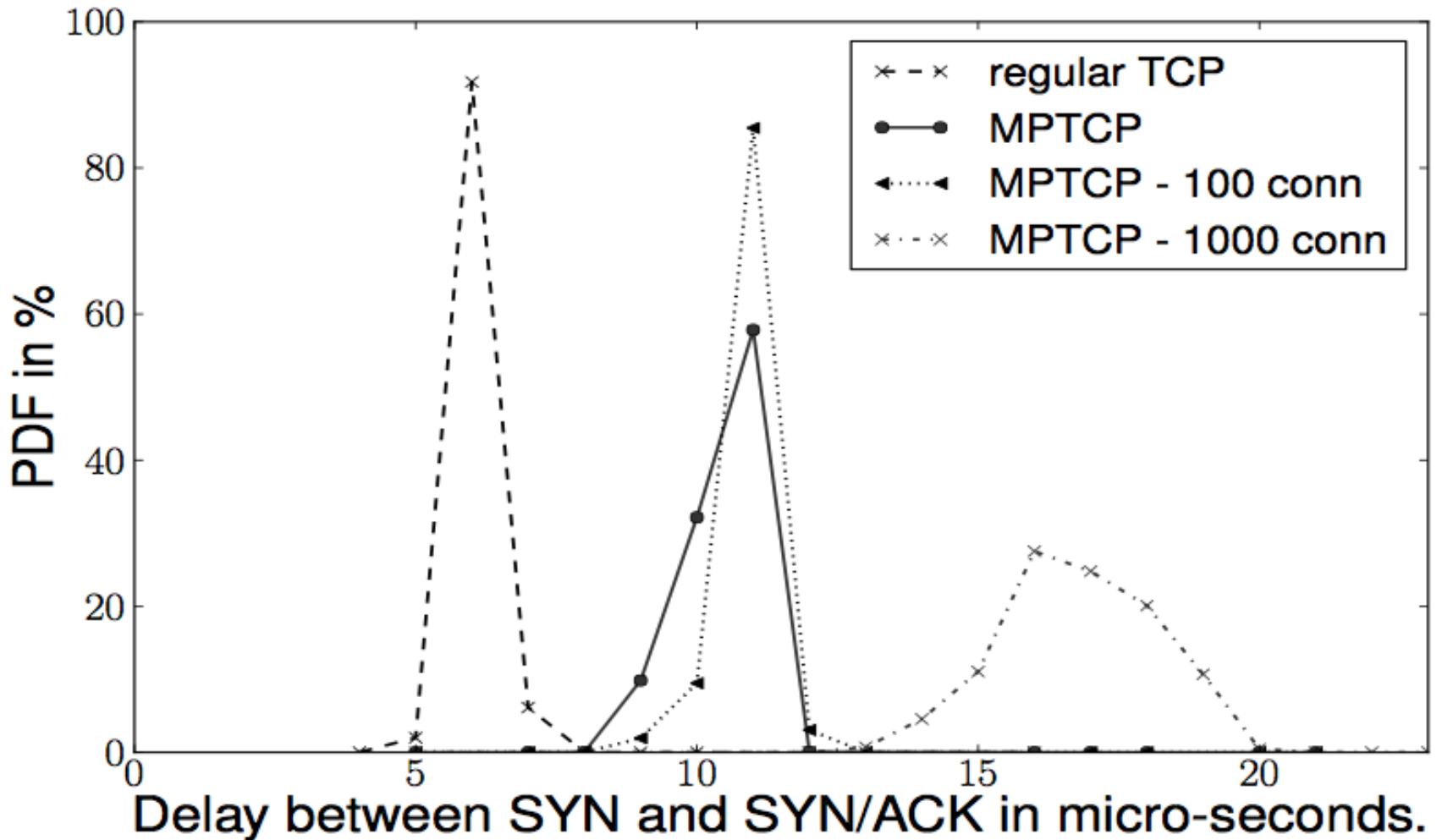

The Multipath TCP control plane

- Connection establishment in details
- Closing a Multipath TCP connection
- Address dynamics

Closing a Multipath TCP connection

- How to close a Multipath TCP connection ?
 - By closing all subflows ?

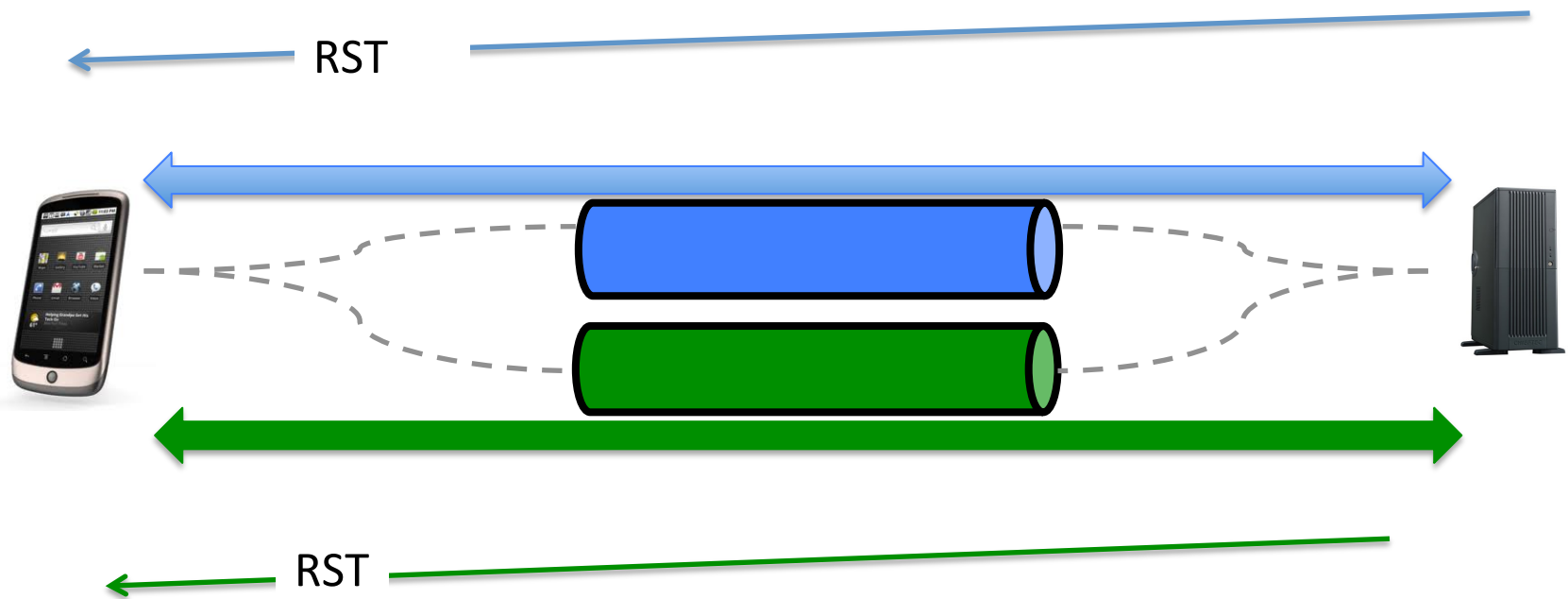

Closing a Multipath TCP connection

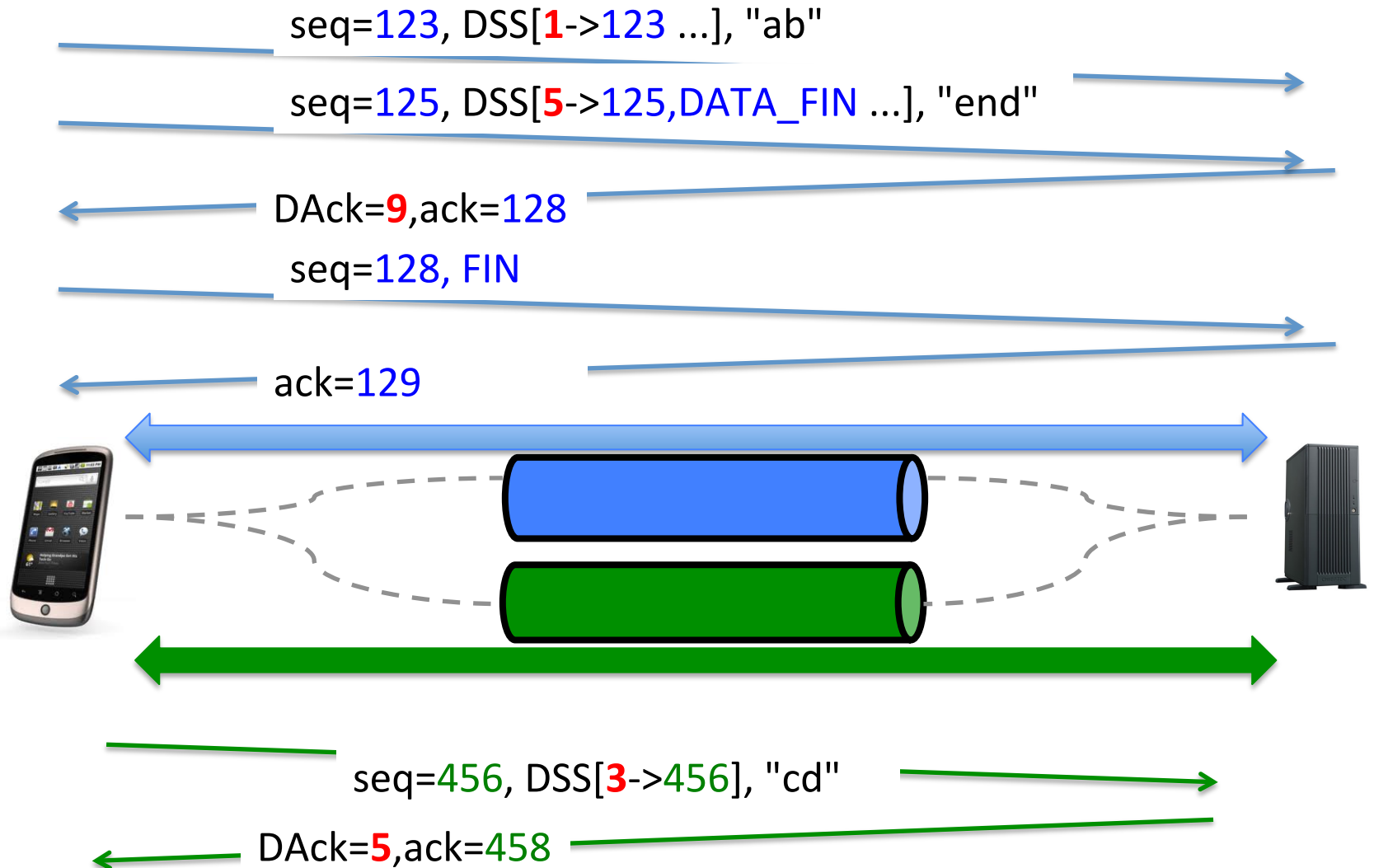

Closing a Multipath TCP connection

- FAST Close

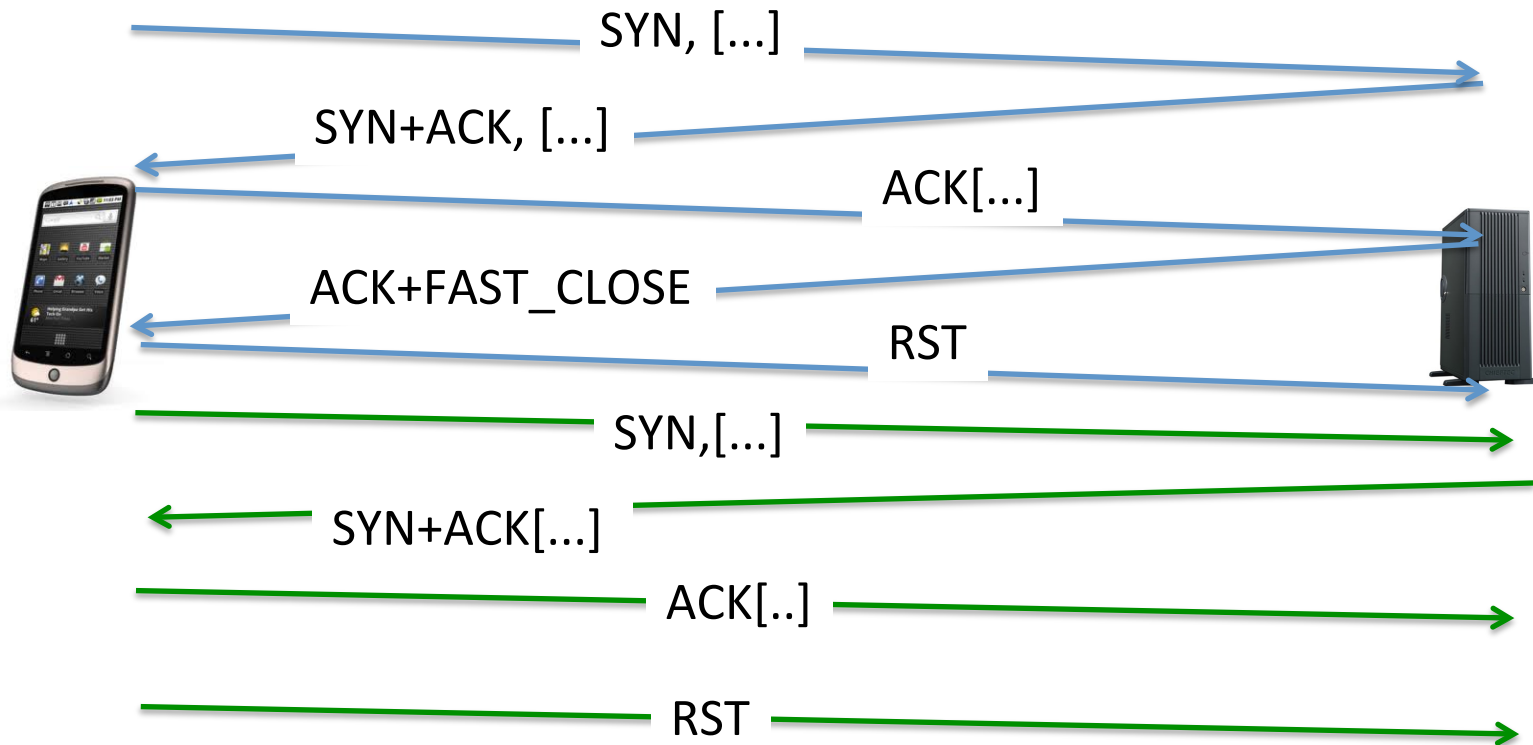

The Multipath TCP control plane

- Connection establishment in details
- Closing a Multipath TCP connection
- Address dynamics

Multipath TCP

Address dynamics

- How to learn the addresses of a host ?

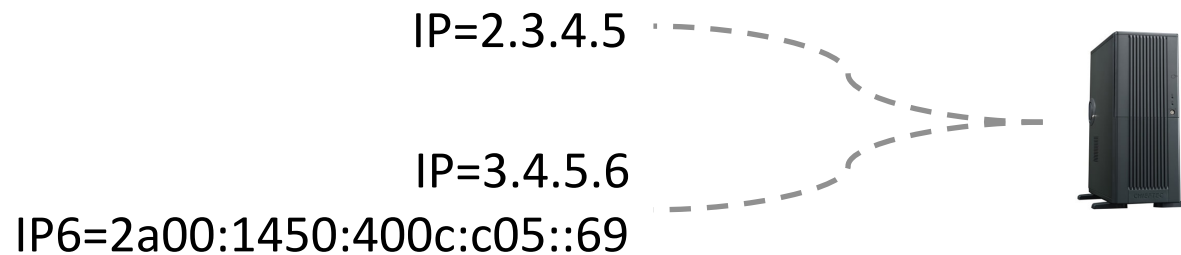

- How to deal with address changes

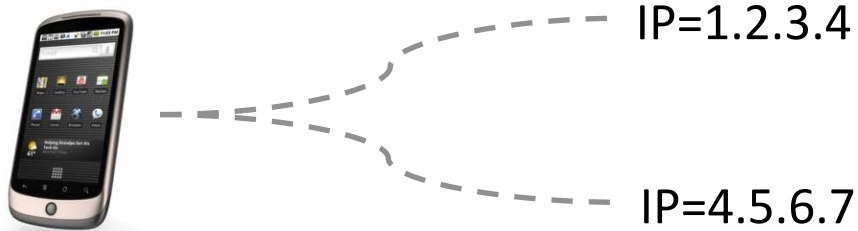

Address dynamics

- Basic solution : multihomed server

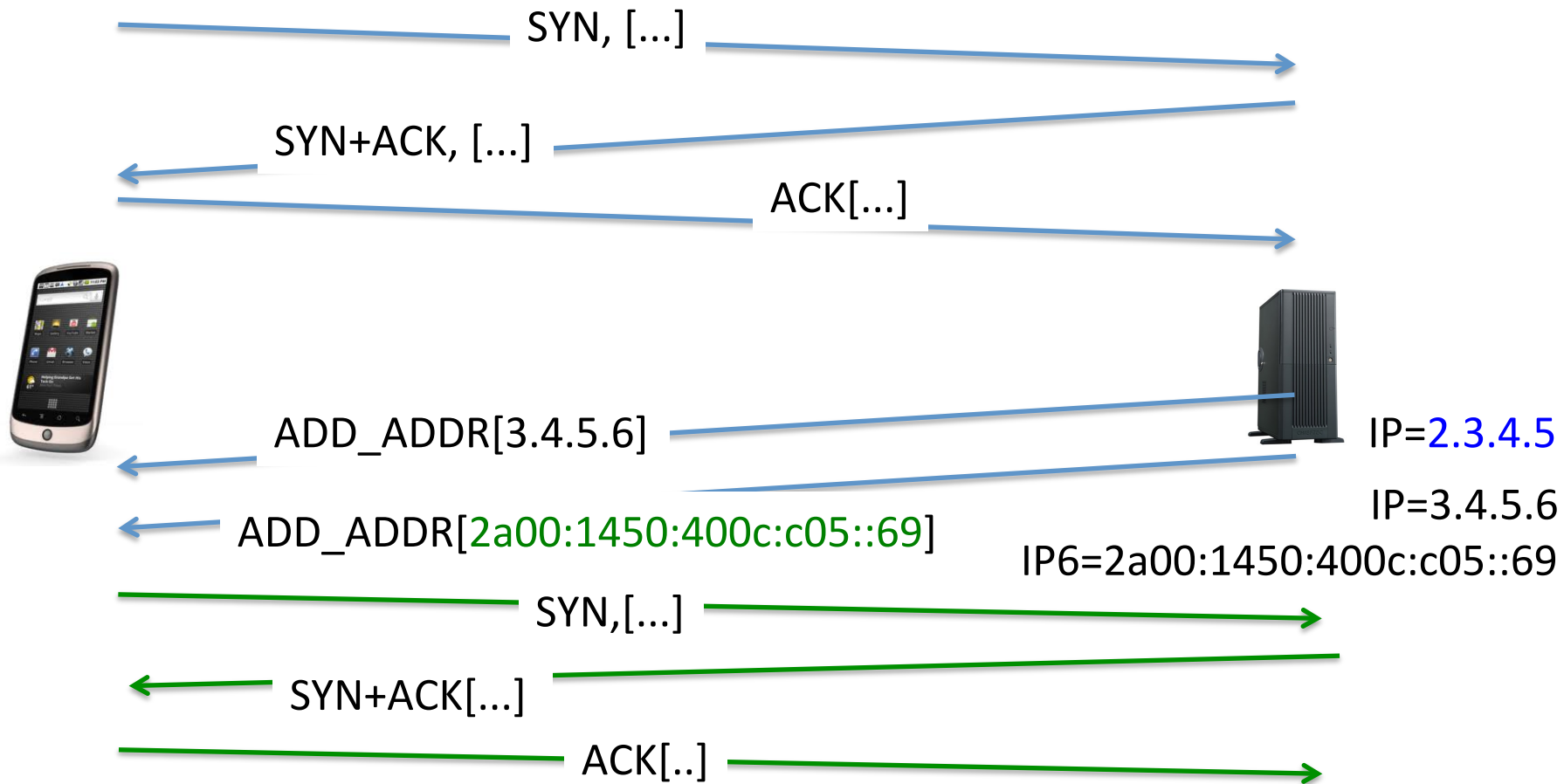

Address dynamics

- Basic solution : mobile client

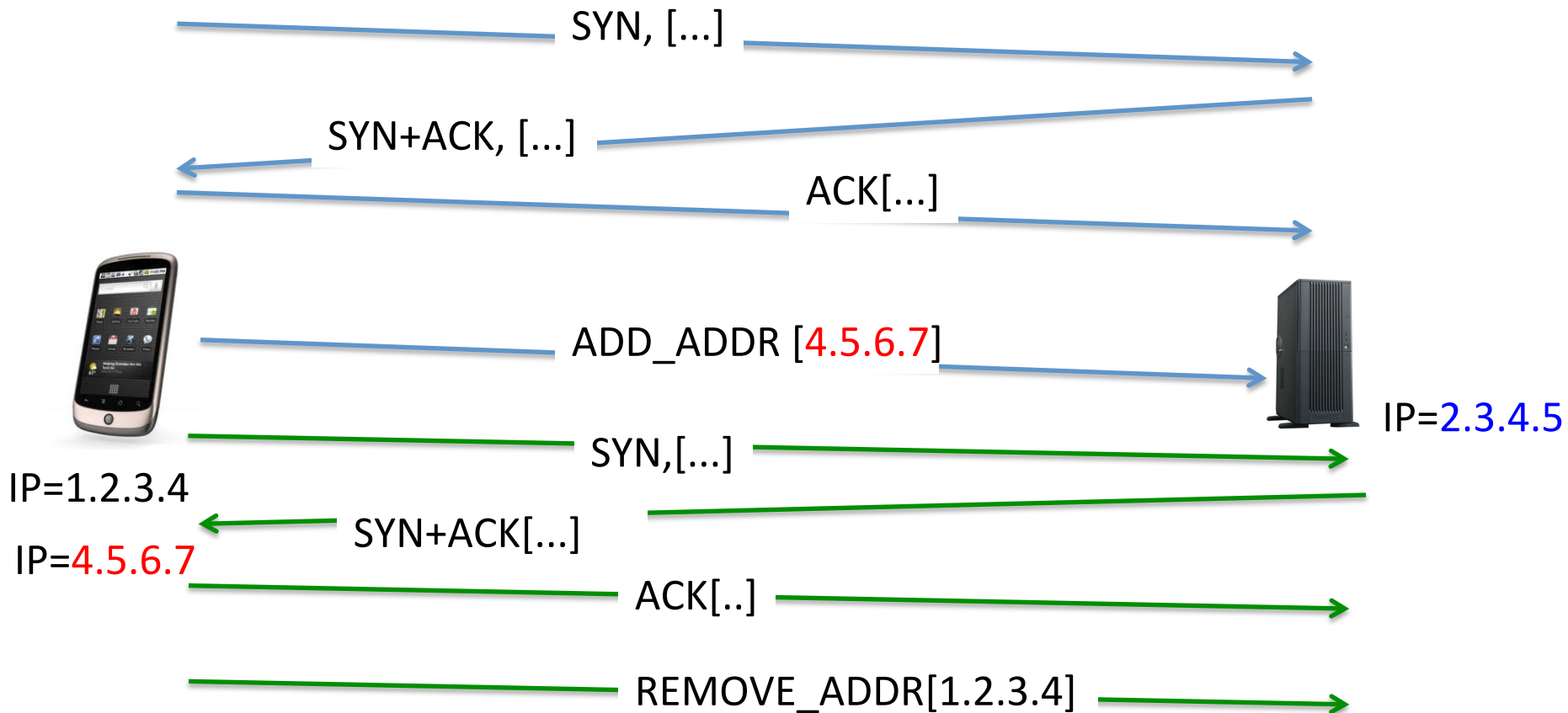

Address dynamics in today's Internet

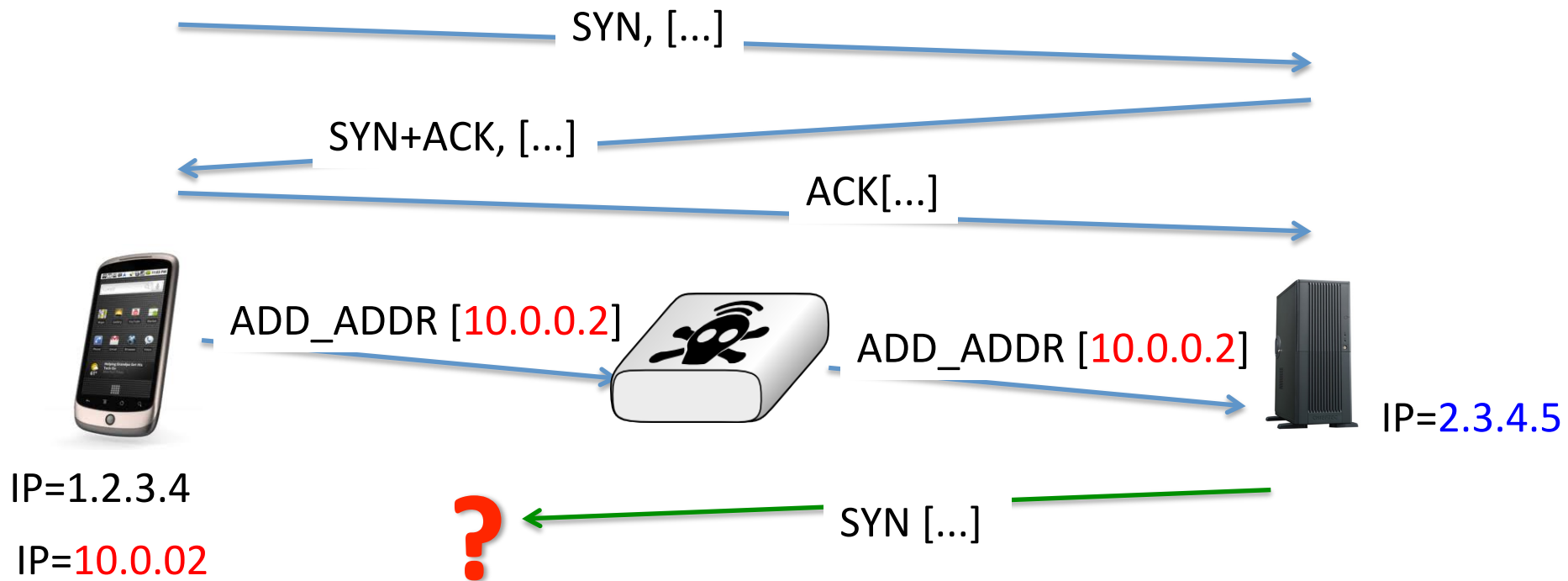

Address dynamics with NATs

- Solution
 - Each address has one identifier
 - Subflow is established between id=0 addresses
 - Each host maintains a list of <address,id> pairs of the addresses associated to an MPTCP endpoint
 - MPTCP options refer to the address identifier
 - ADD_ADDR contains <address,id>
 - REMOVE_ADDR contains <id>

Address dynamics

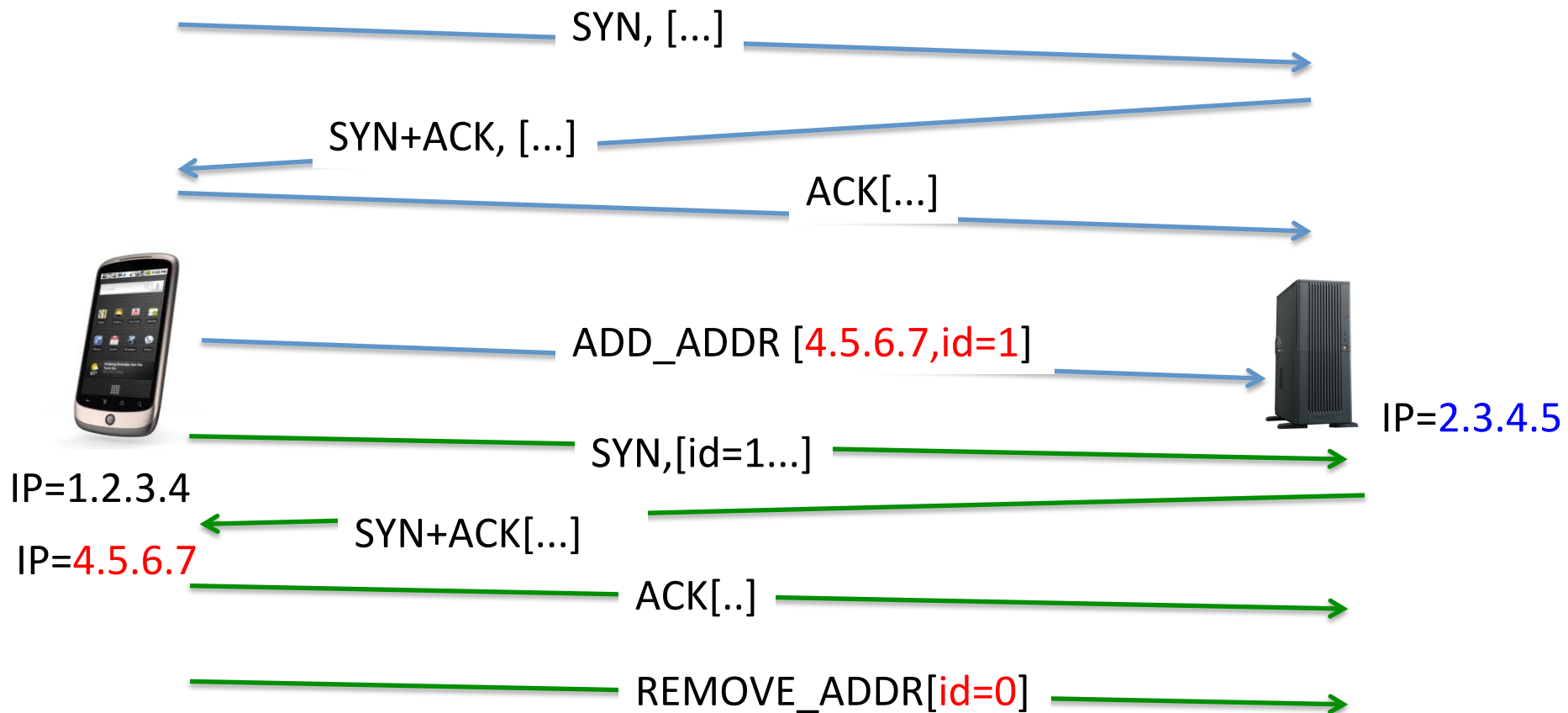

Agenda

- The motivations for Multipath TCP
- The changing Internet
- The Multipath TCP Protocol
- Multipath TCP use cases
 - ➔ Datacenters
 - Smartphones

Datacenters evolve

- Traditional Topologies are tree-based
 - Poor performance
 - Not fault tolerant

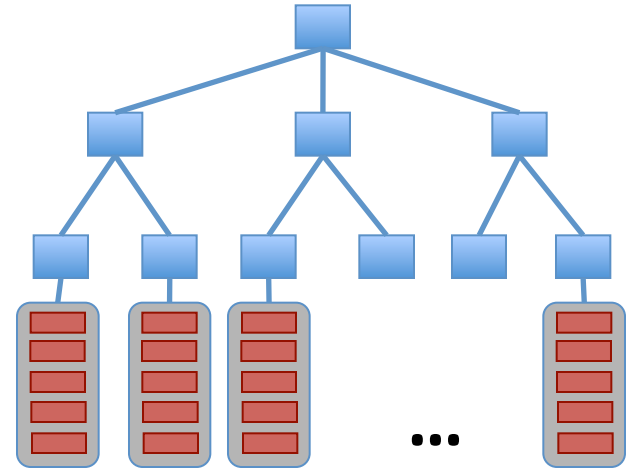

- Shift towards multipath topologies:
FatTree, BCube, VL2,
Cisco, EC2

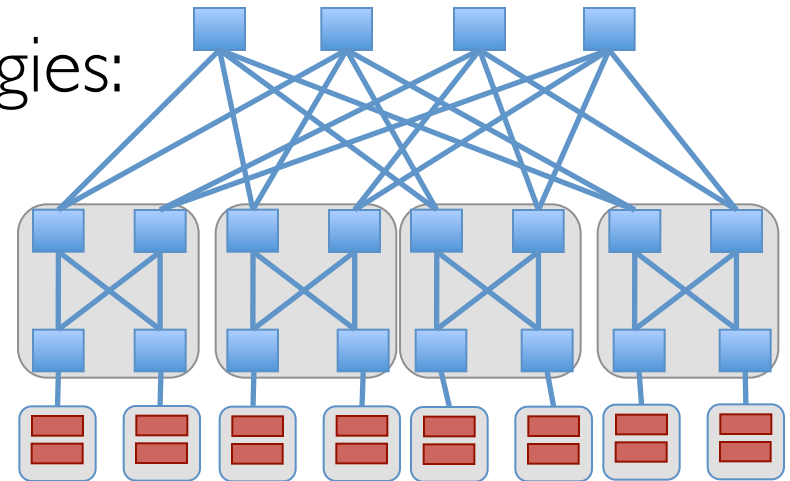

Fat Tree Topology [Fares et al., 2008; Clos, 1953]

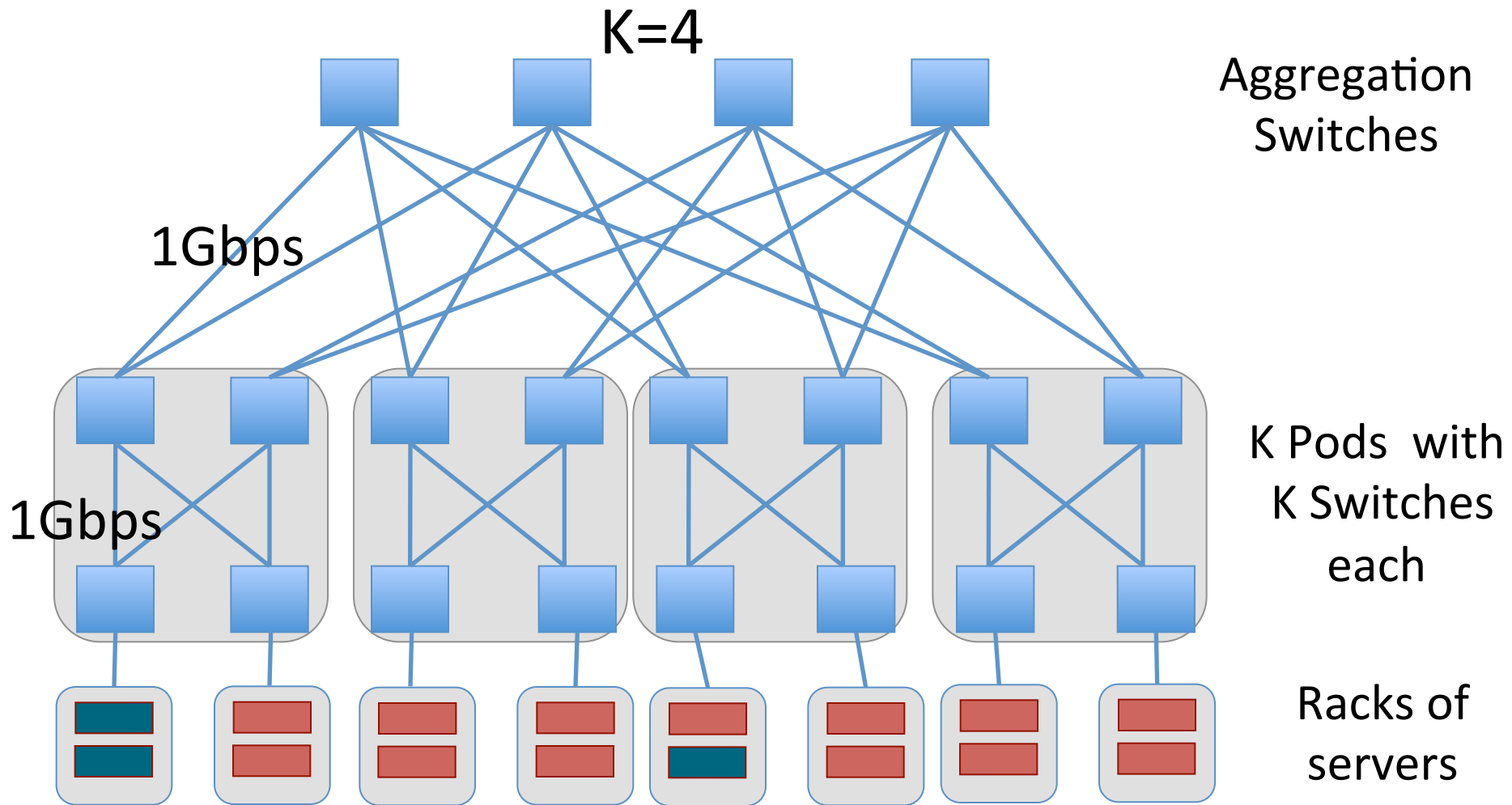

Fat Tree Topology [Fares et al., 2008; Clos, 1953]

$K=4$

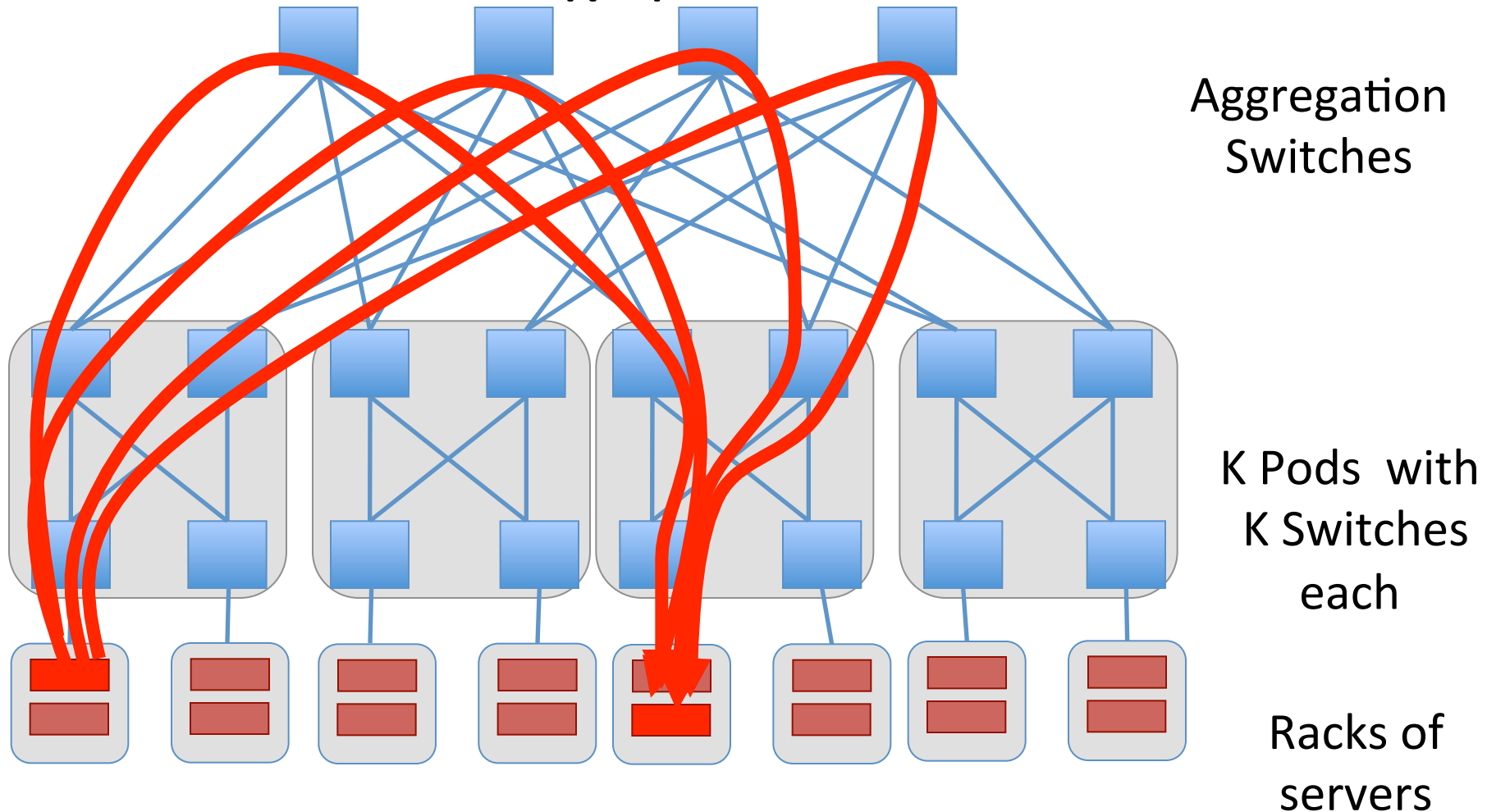

C. Raiciu, et al. "Improving datacenter performance and robustness with multipath TCP," *ACM SIGCOMM* 2011.

Collisions

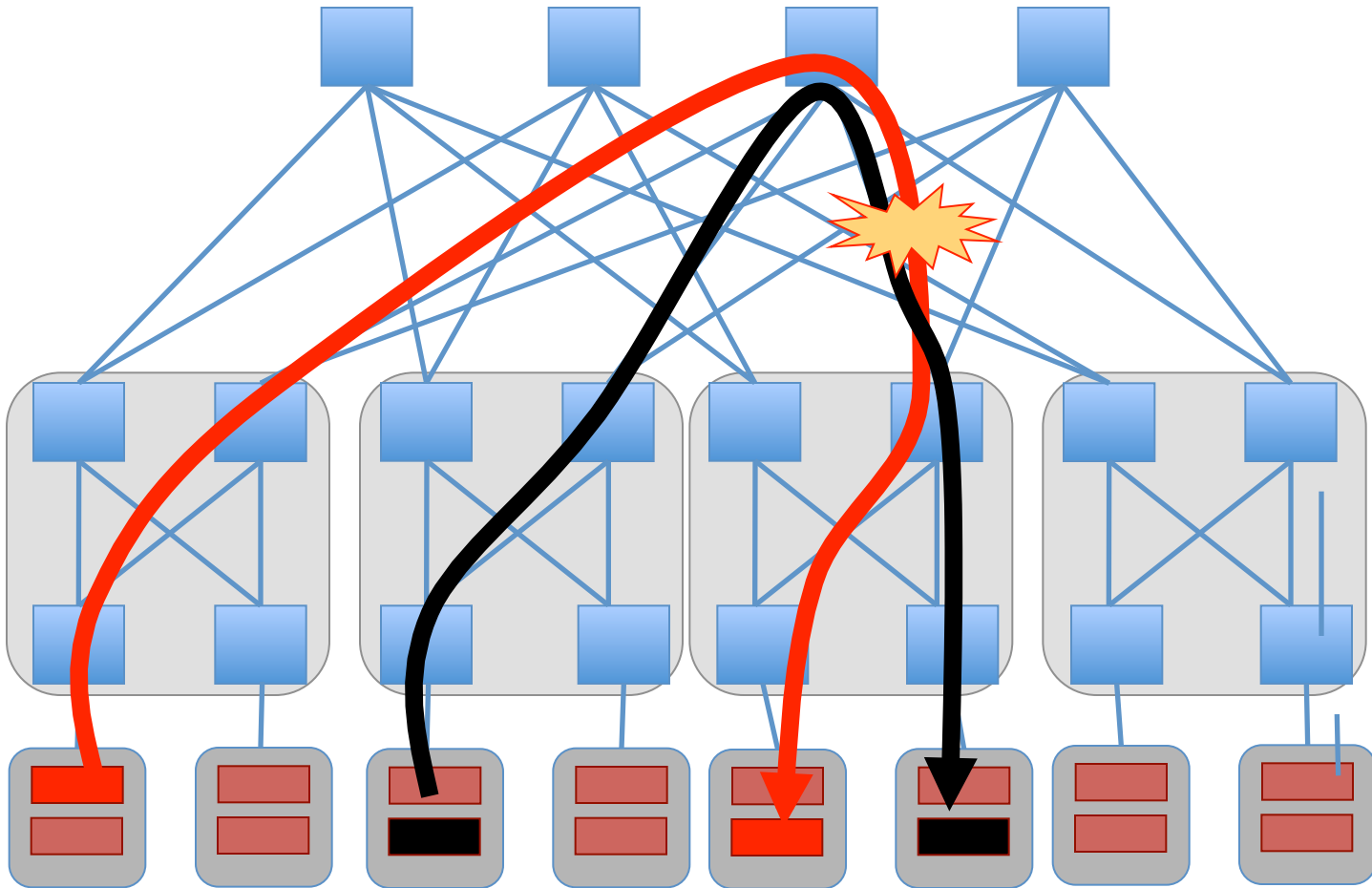

TCP in data centers

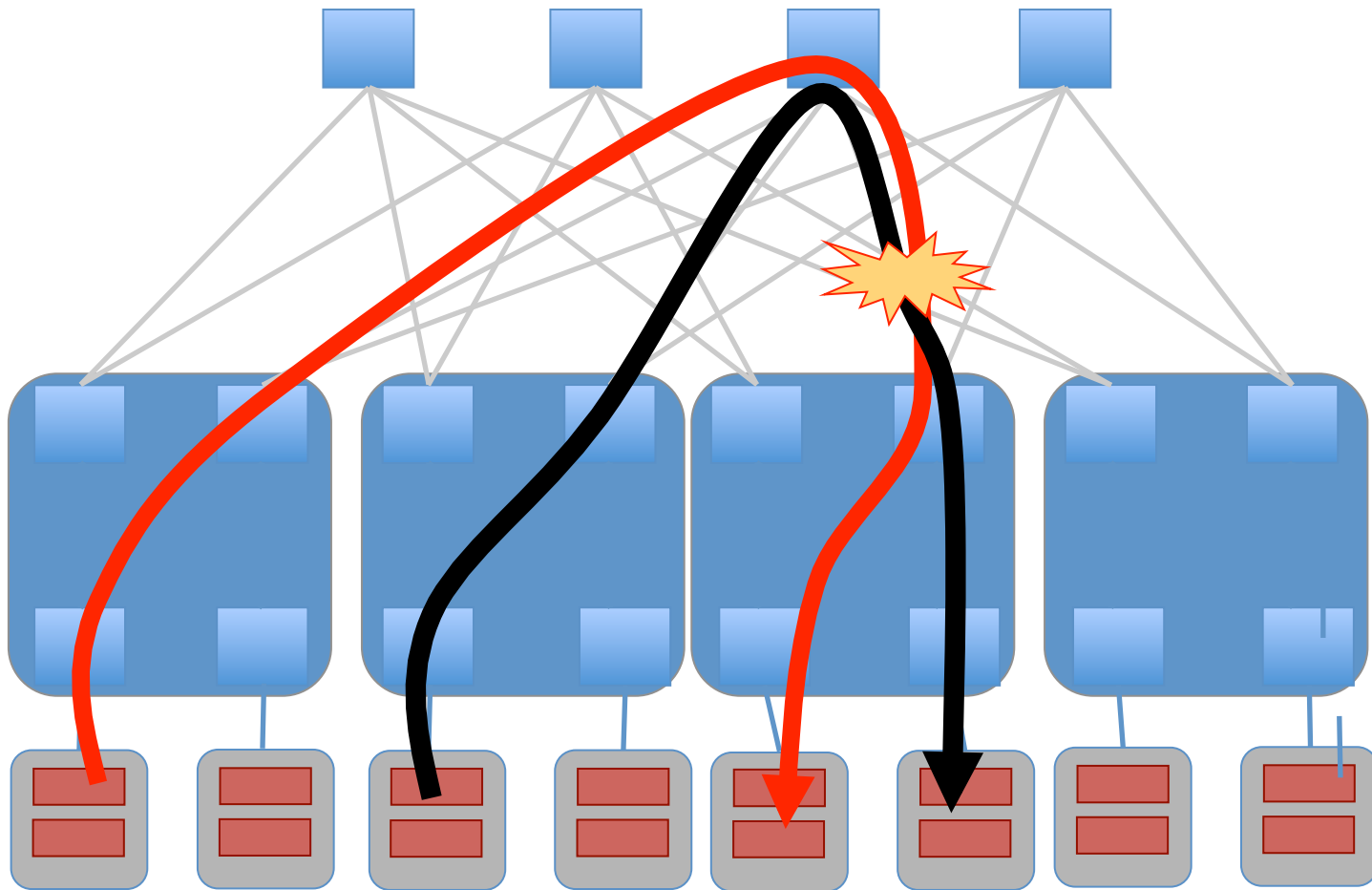

TCP in FAT tree networks

Cost of collisions

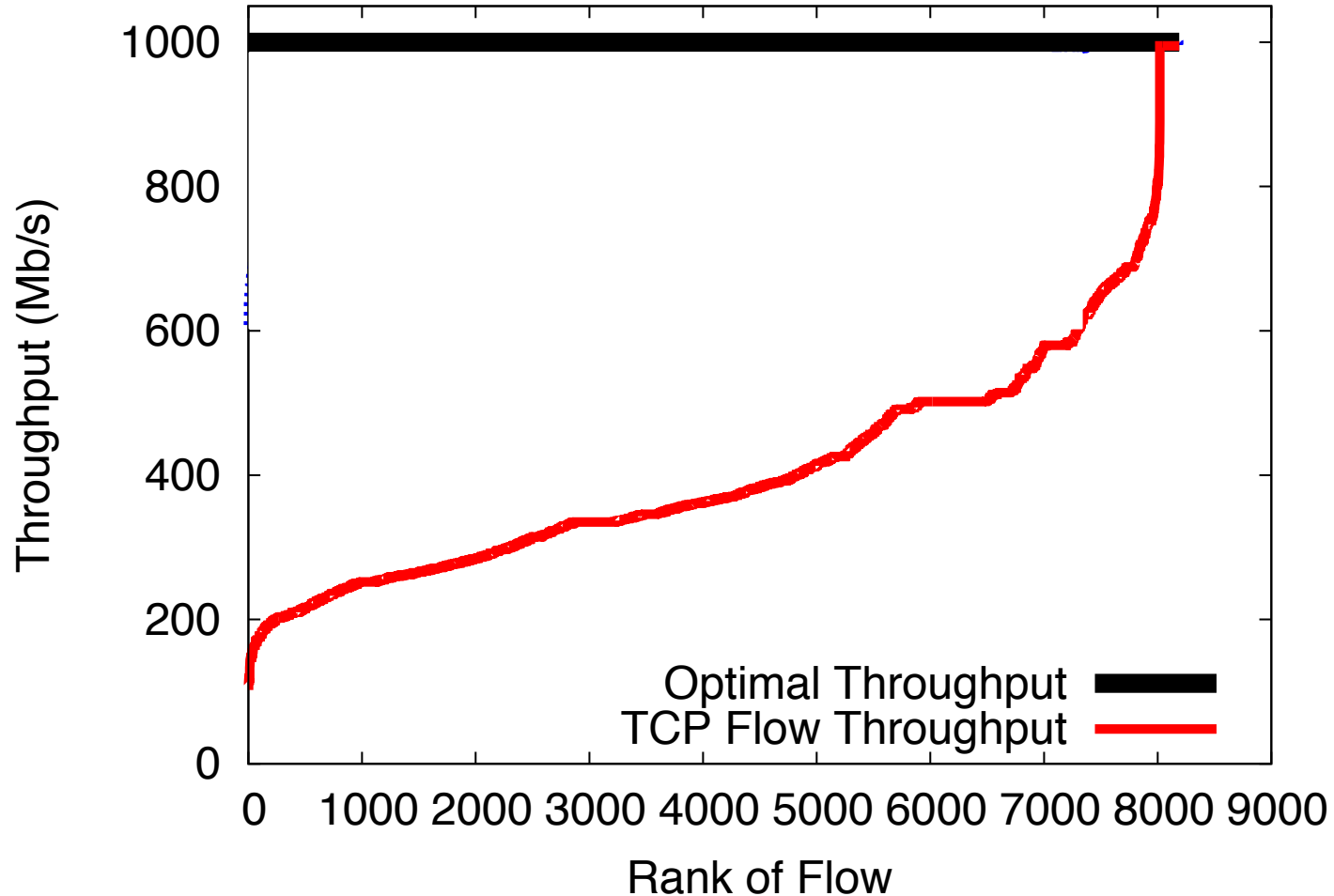

C. Raiciu, et al. "Improving datacenter performance and robustness with multipath TCP," *ACM SIGCOMM* 2011.

How to get rid of these collisions ?

- Consider TCP performance as an optimisation problem

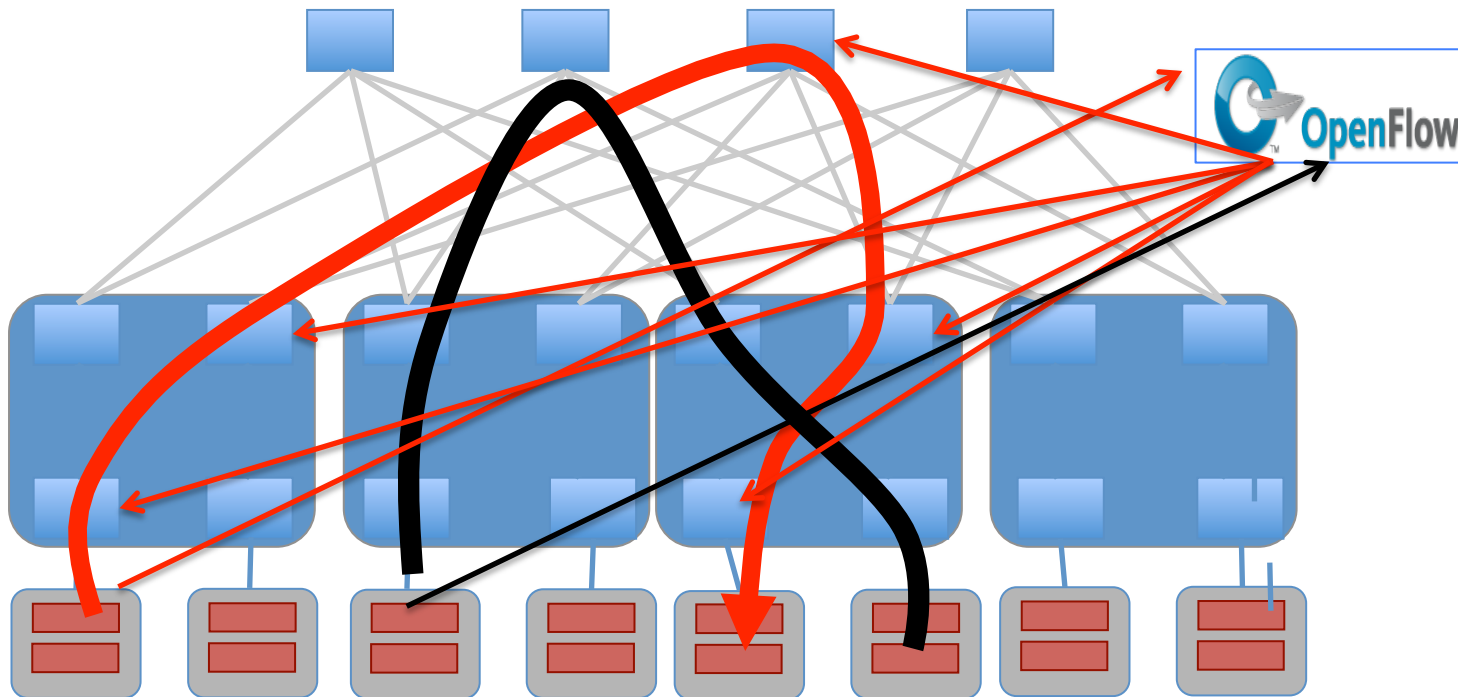

The Multipath TCP way

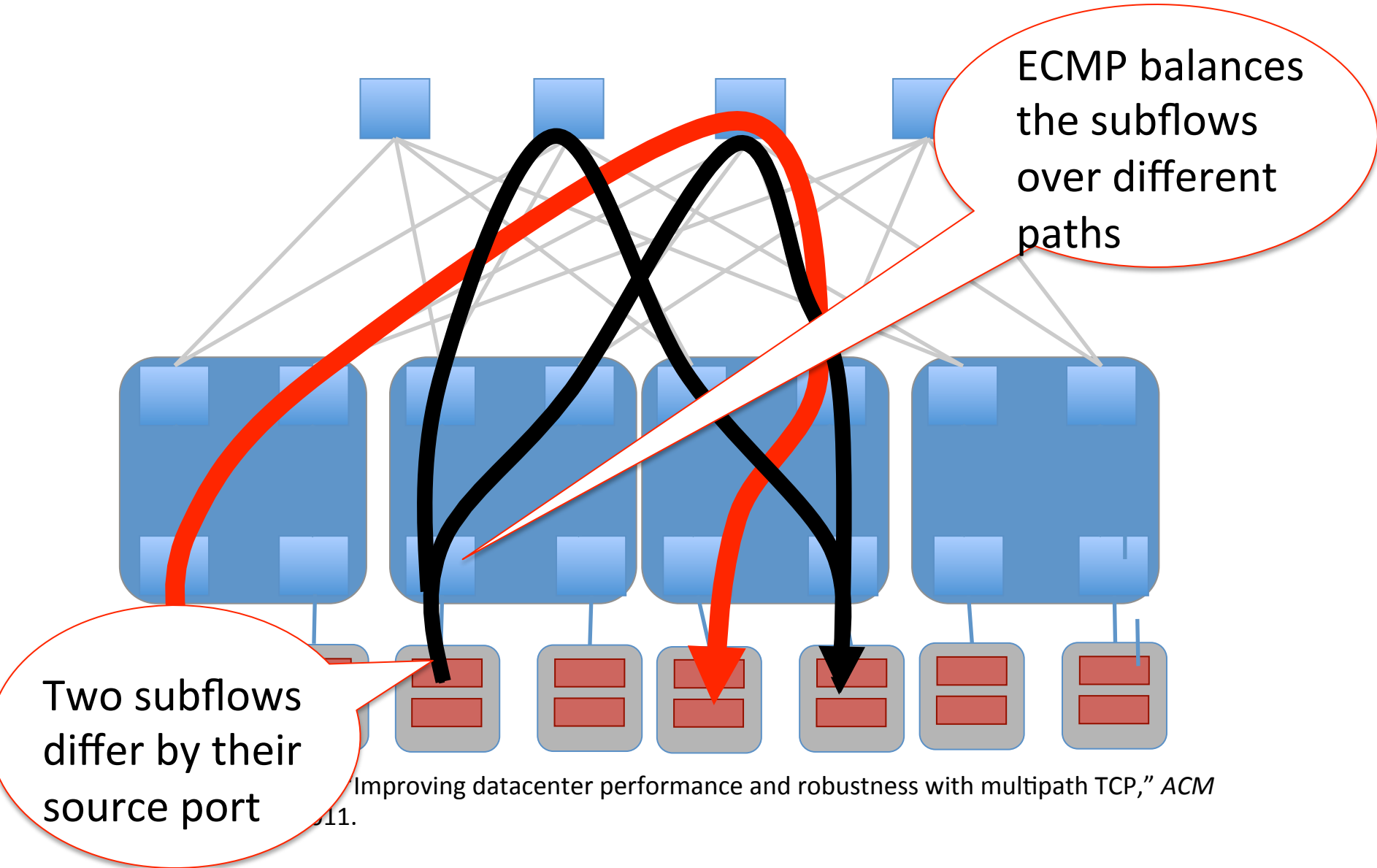

MPTCP better utilizes the FatTree network

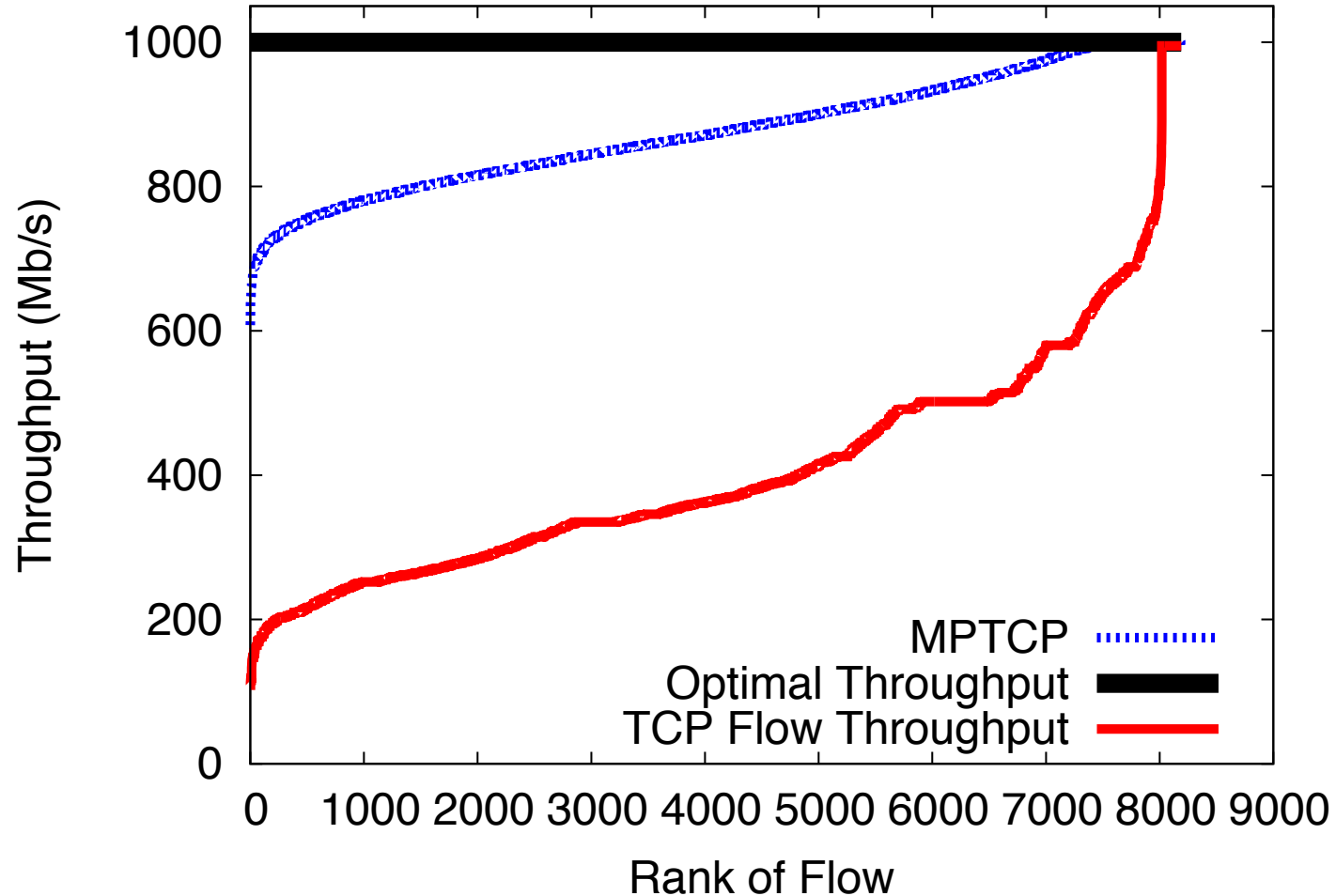

C. Raiciu, et al. "Improving datacenter performance and robustness with multipath TCP," *ACM SIGCOMM* 2011.

How many subflows does Multipath TCP need ?

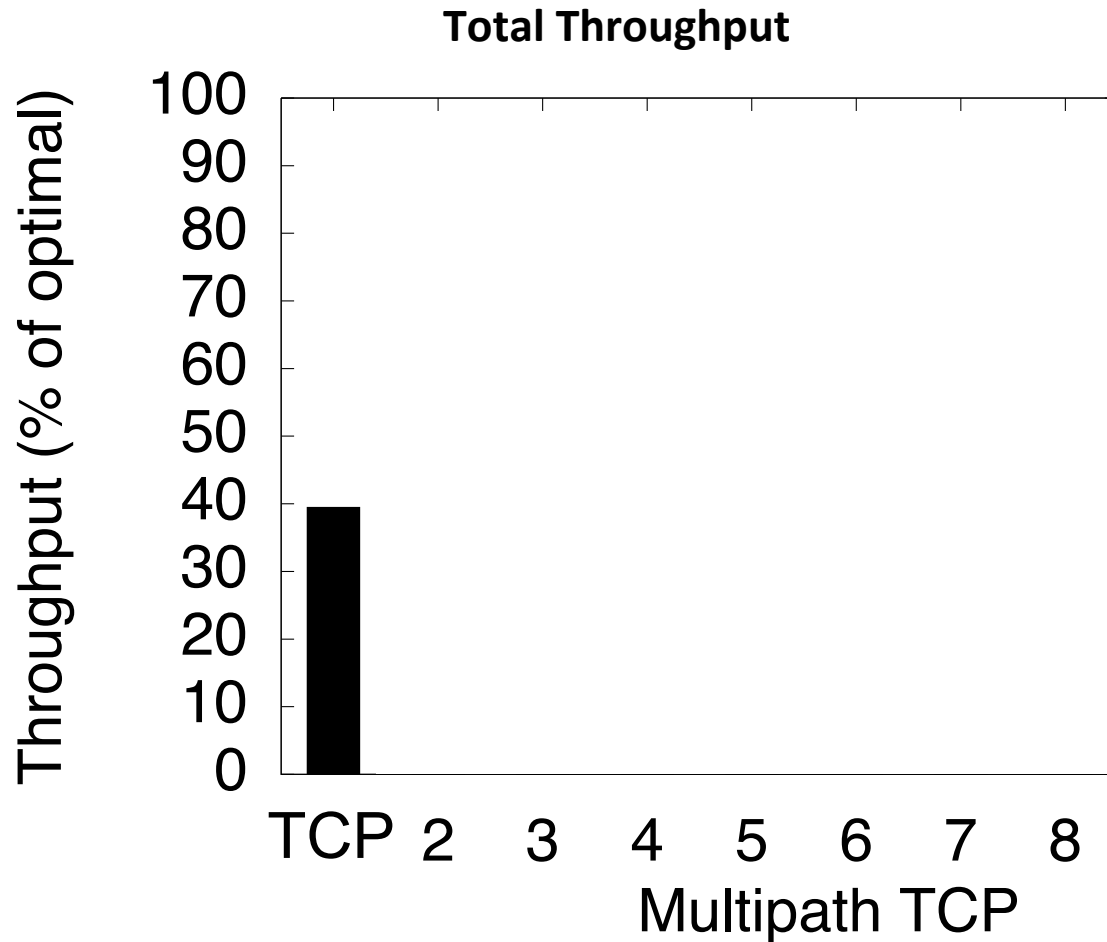

Can we improve Multipath TCP ?

- Two subflows may follow similar paths

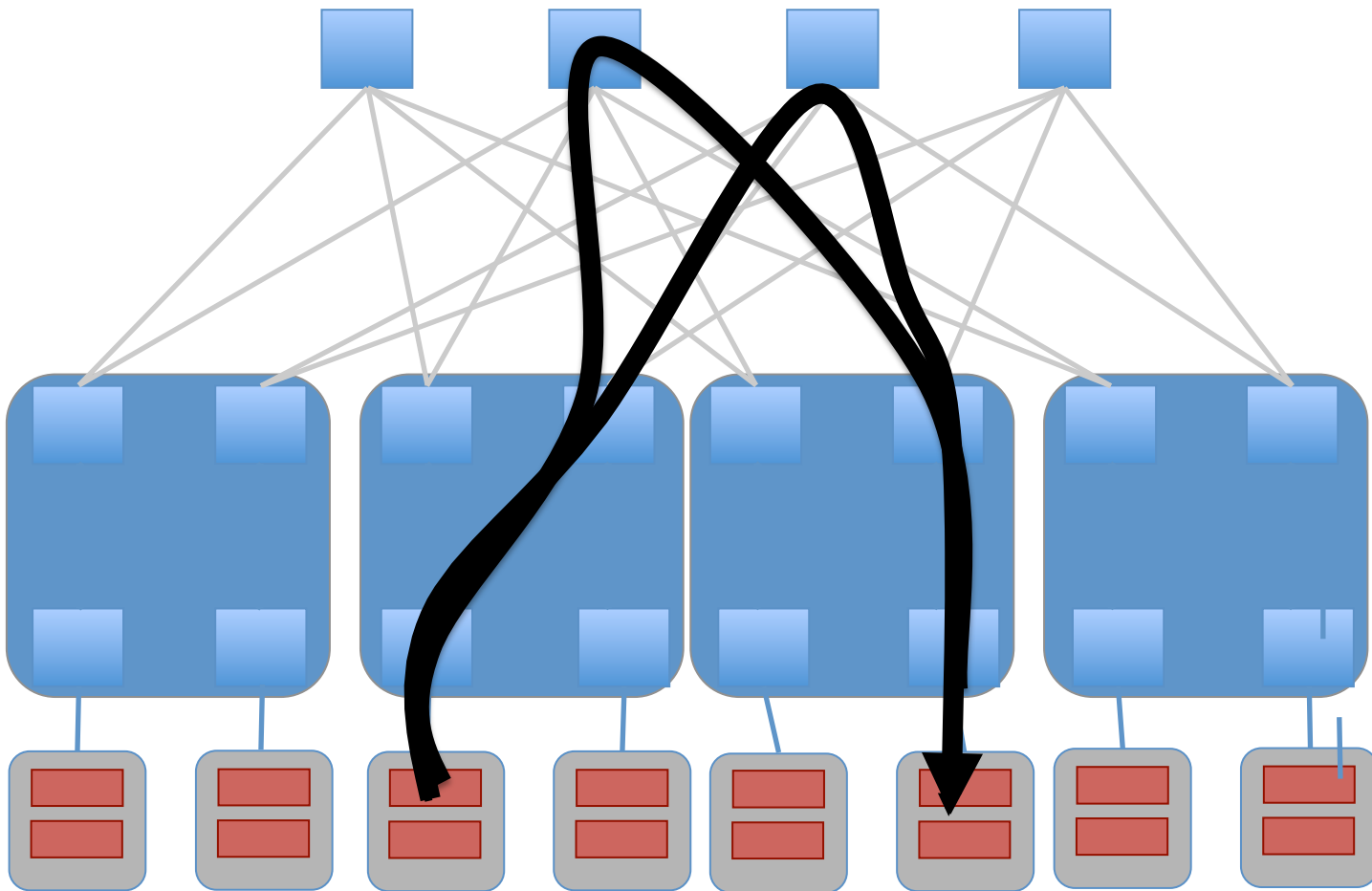

Improving ECMP

- ECMP's hash
 - good load balancing
 - impossible to predict result

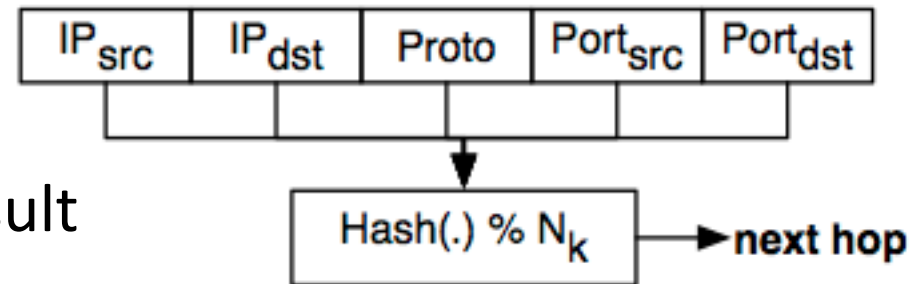

- CFLB
 - replaces hash with block cipher
 - hosts can select paths for Multipath TCP subflows provided they know datacenter topology

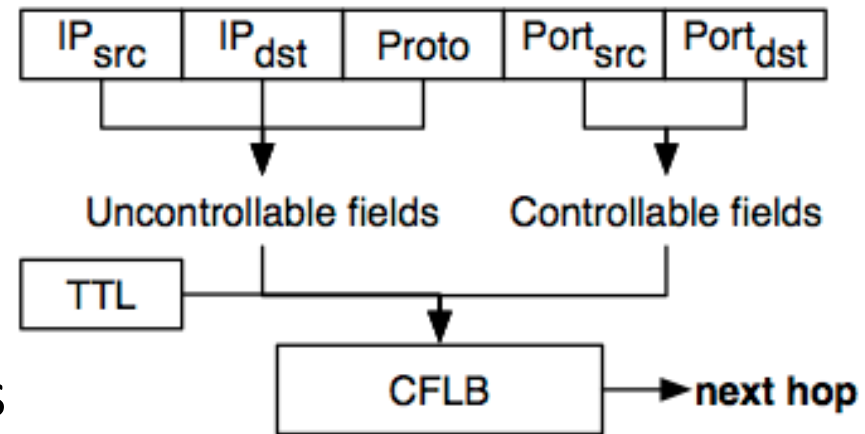

Multipath TCP with CFLB in Fat-Tree

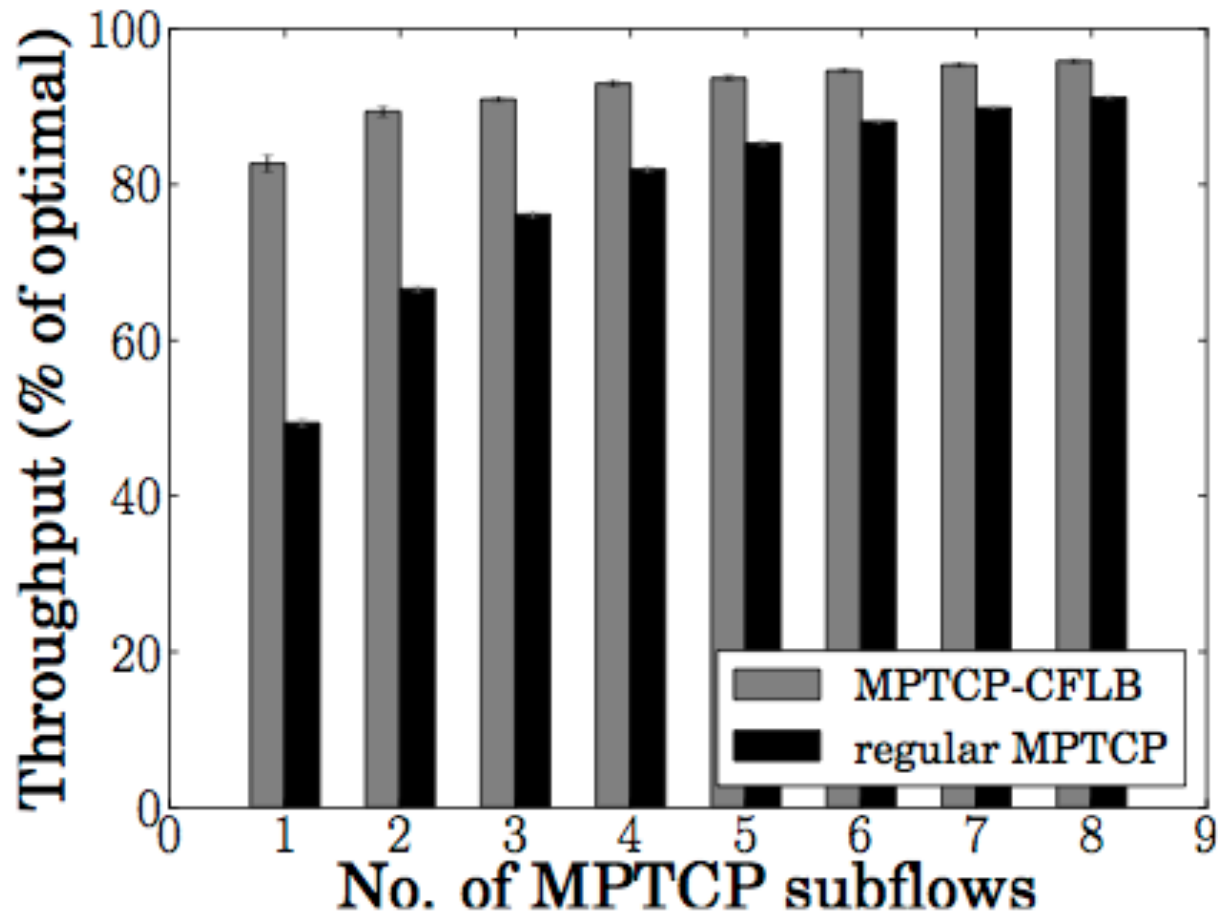

Multipath TCP on EC2

- Amazon EC2: infrastructure as a service
 - We can borrow virtual machines by the hour
 - These run in Amazon data centers worldwide
 - We can boot our own kernel
- A few availability zones have multipath topologies
 - 2-8 paths available between hosts not on the same machine or in the same rack
 - Available via ECMP

Amazon EC2 Experiment

- 40 medium CPU instances running MPTCP
- During 12 hours, we sequentially ran all-to-all iperf cycling through:
 - TCP
 - MPTCP (2 and 4 subflows)

MPTCP improves performance on EC2

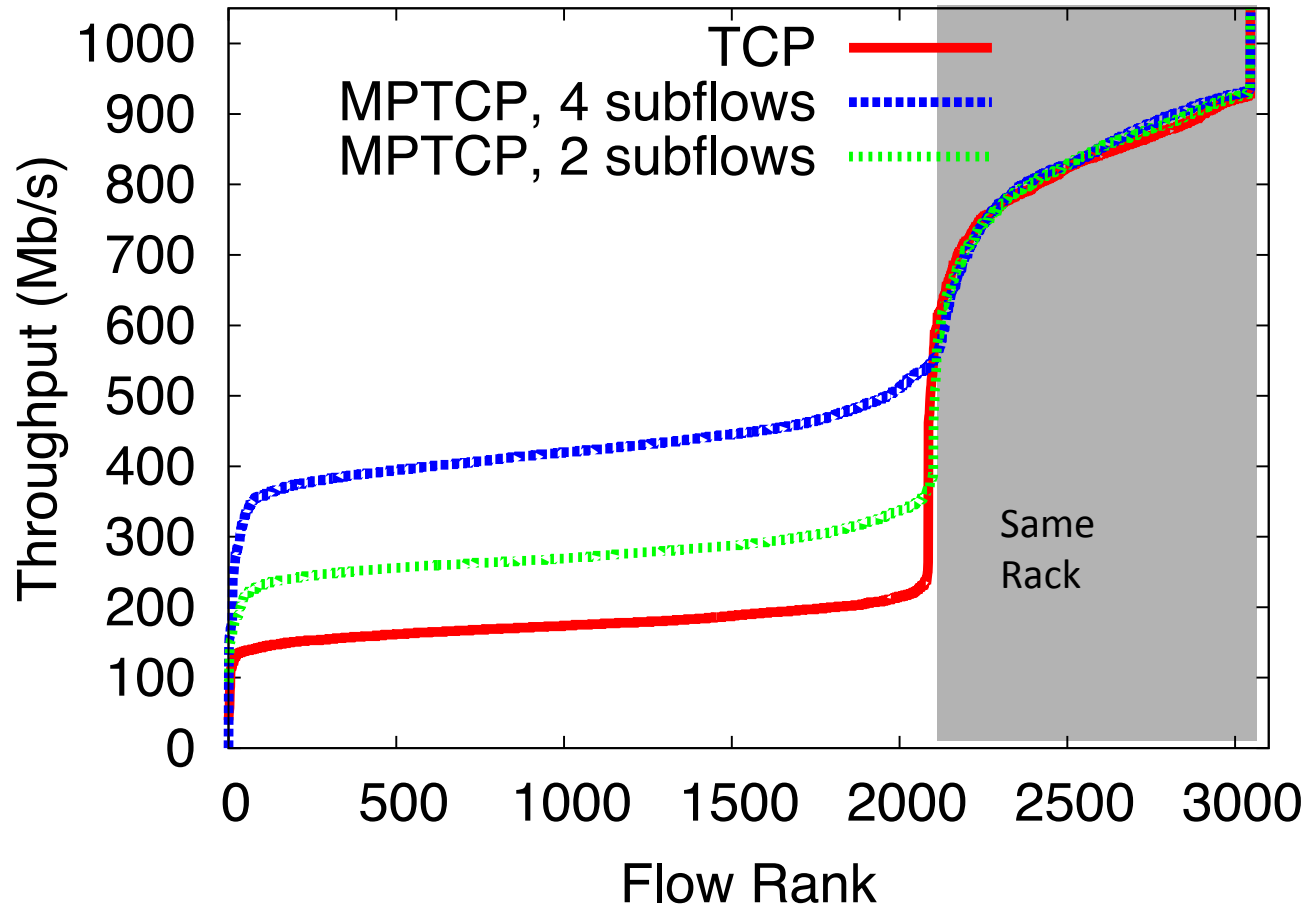

Agenda

- The motivations for Multipath TCP
- The changing Internet
- The Multipath TCP Protocol
- Multipath TCP use cases
 - Datacenters
 -  Smartphones

Motivation

- One device, many IP-enabled interfaces



Bluetooth[®]



MPTCP over WiFi/3G

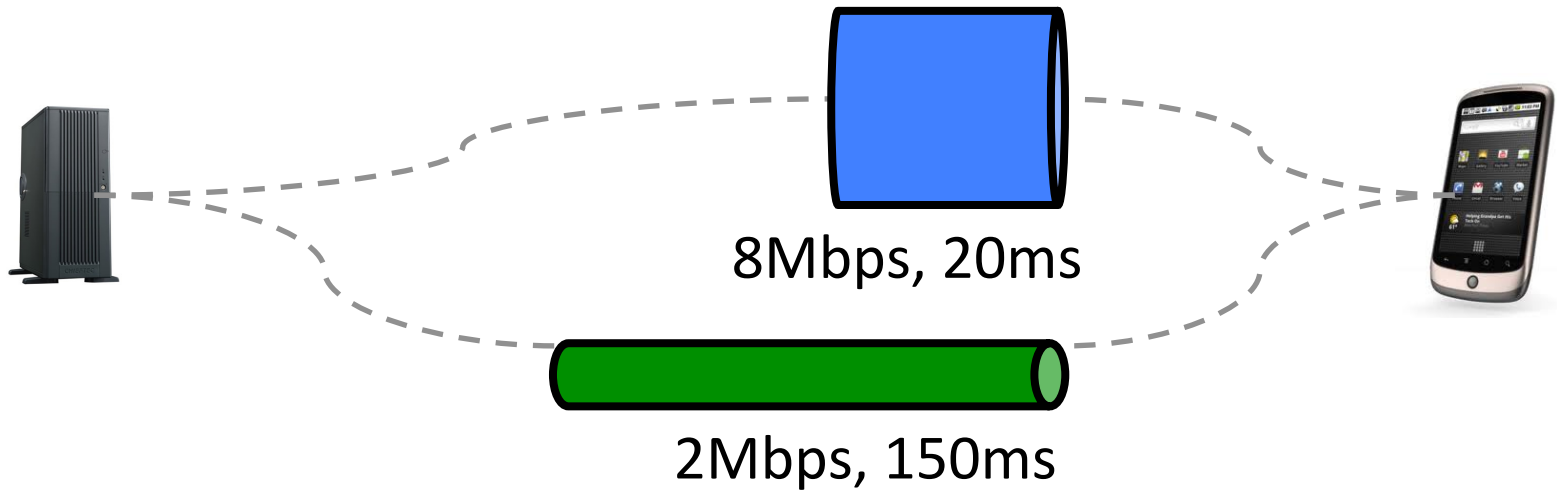

TCP over WiFi/3G

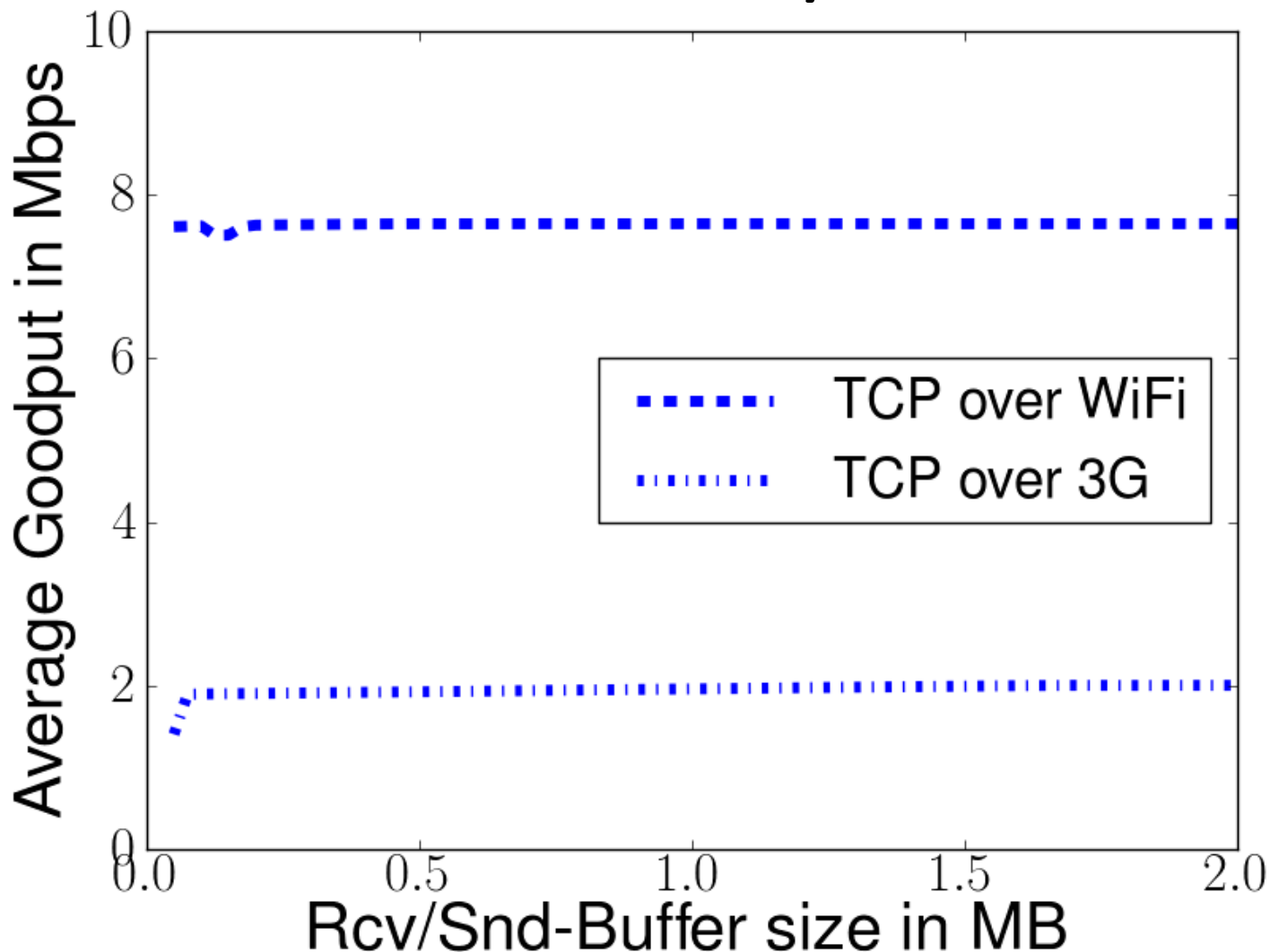

MPTCP over WiFi/3G

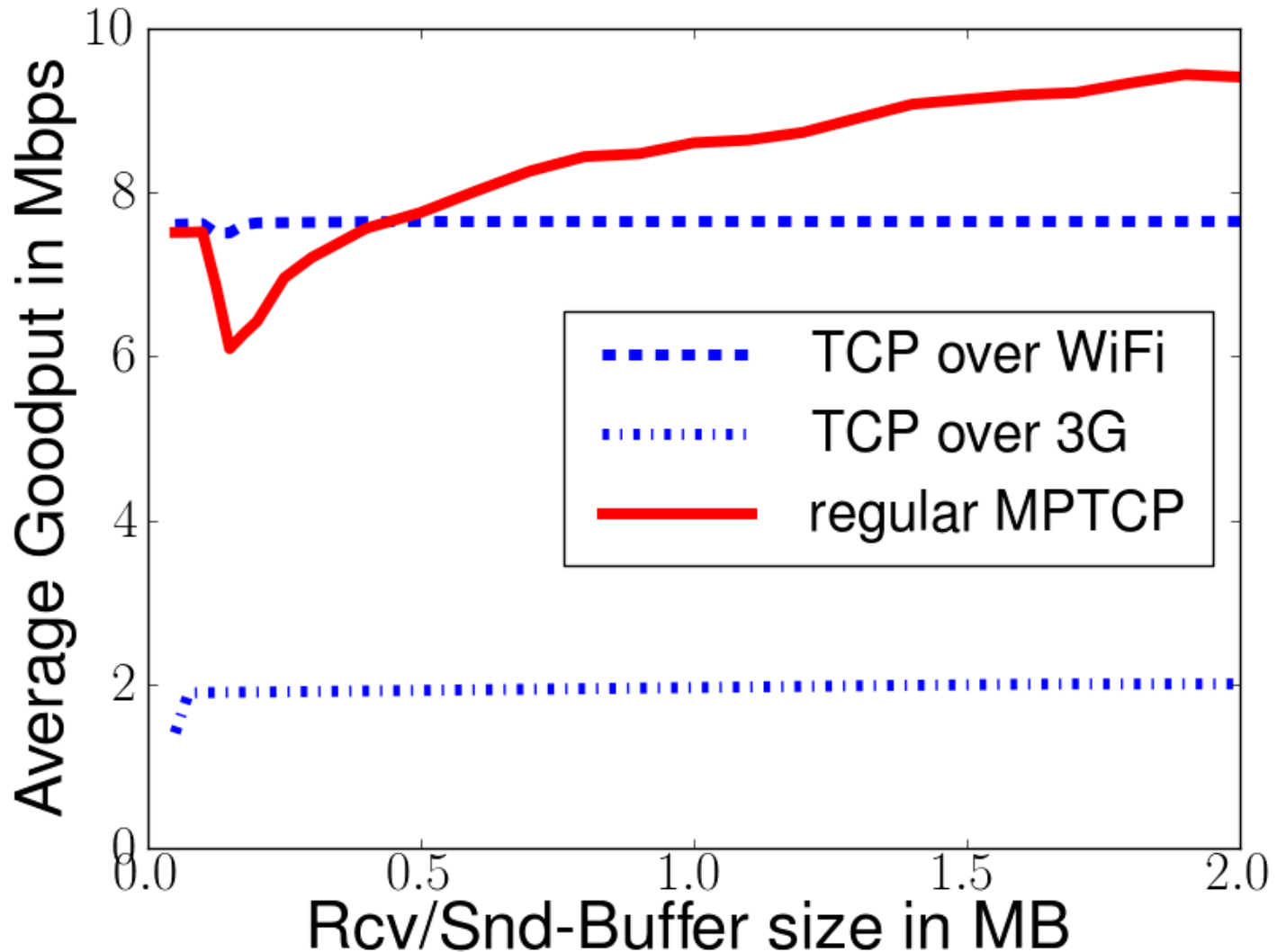

MPTCP over WiFi/3G

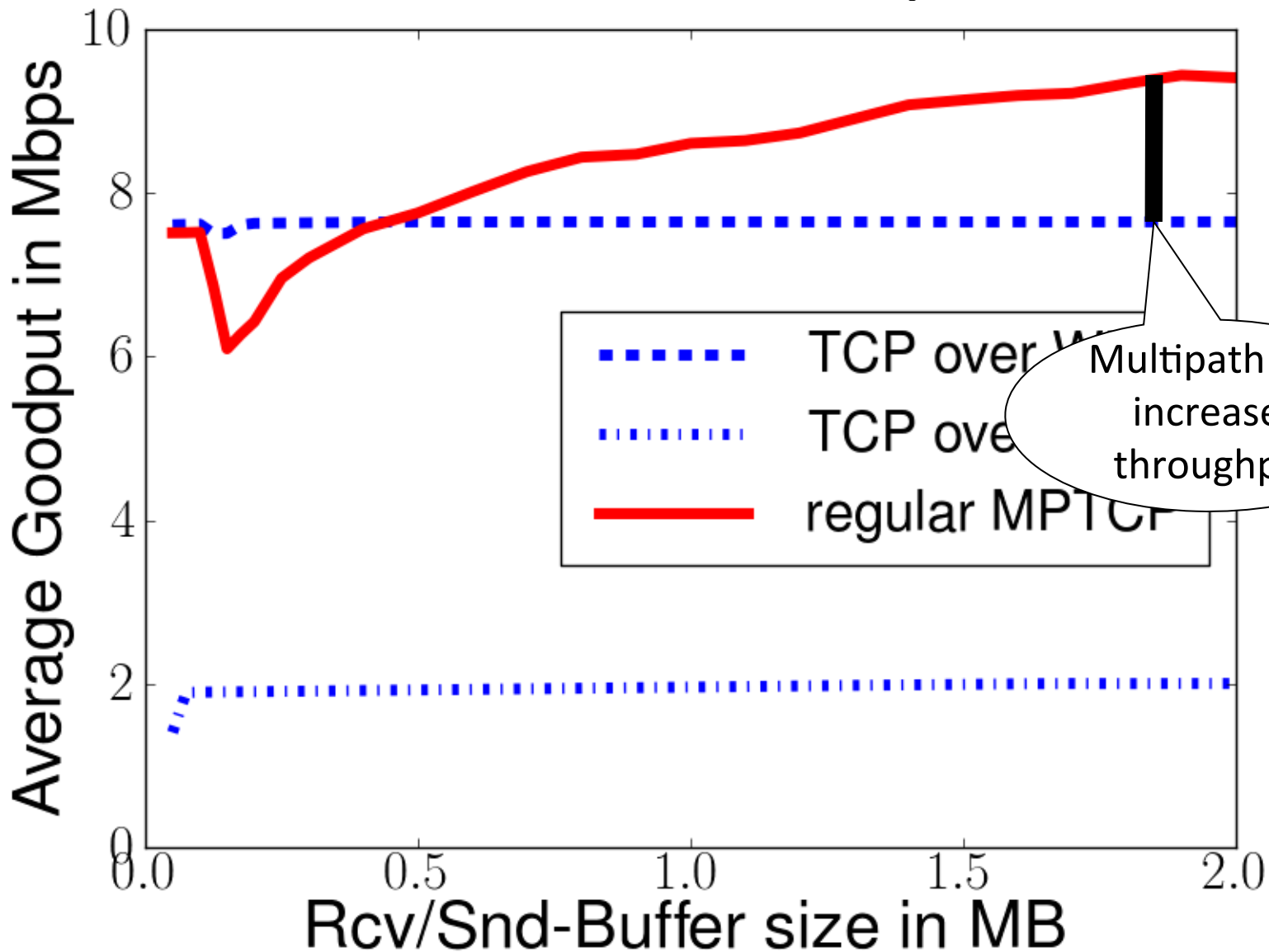

Multipath TCP increases throughput

MPTCP over WiFi/3G

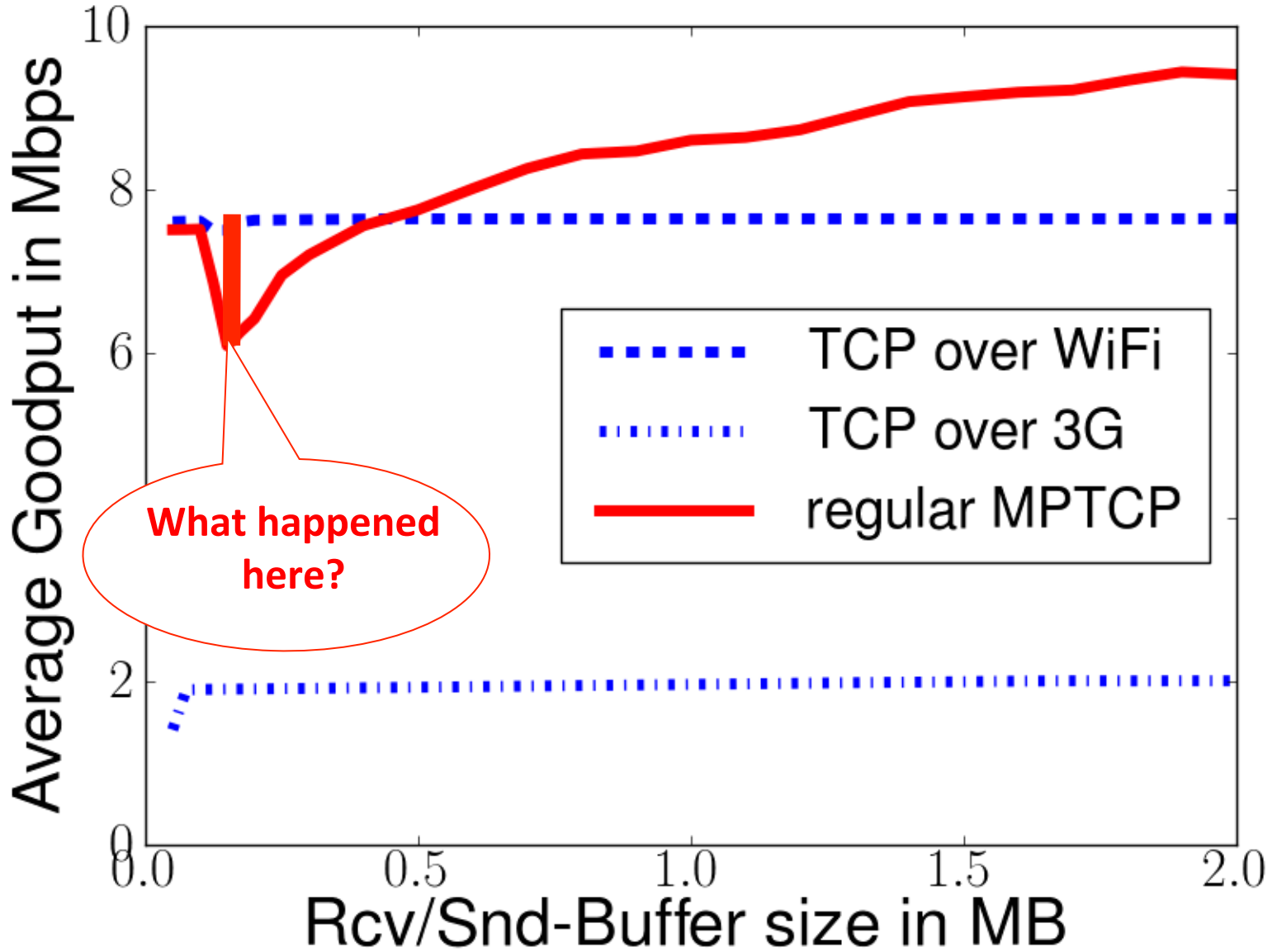

Understanding the performance issue

D C B

Window full !
No new data can be sent on WiFi path

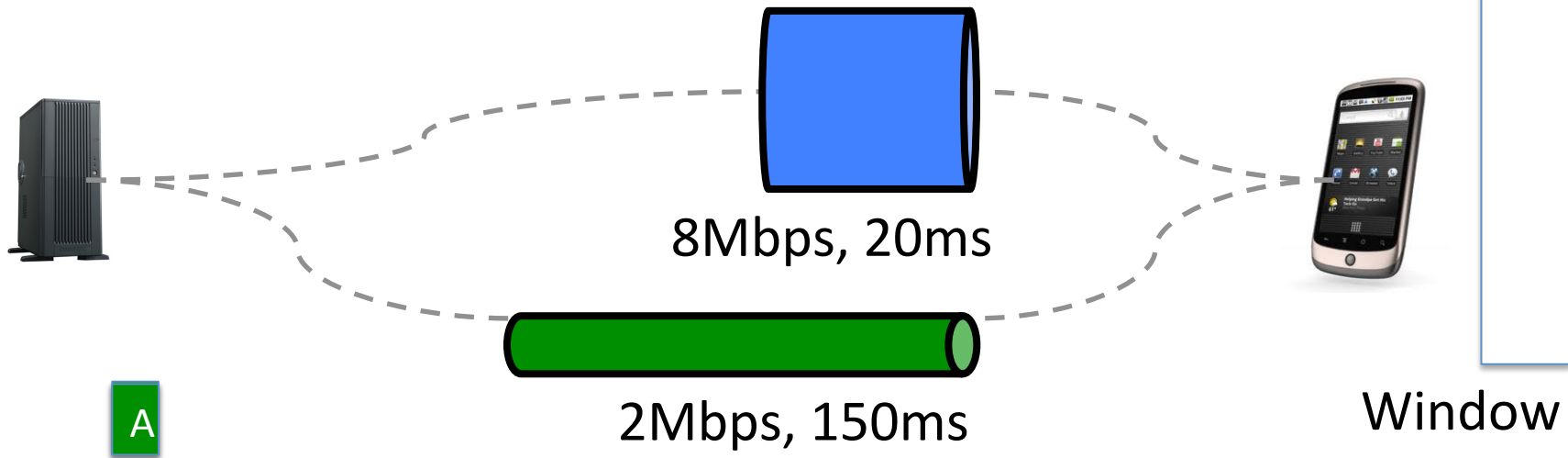

Reinject segment on fast path

Halve congestion window on slow subflow

MPTCP over WiFi/3G

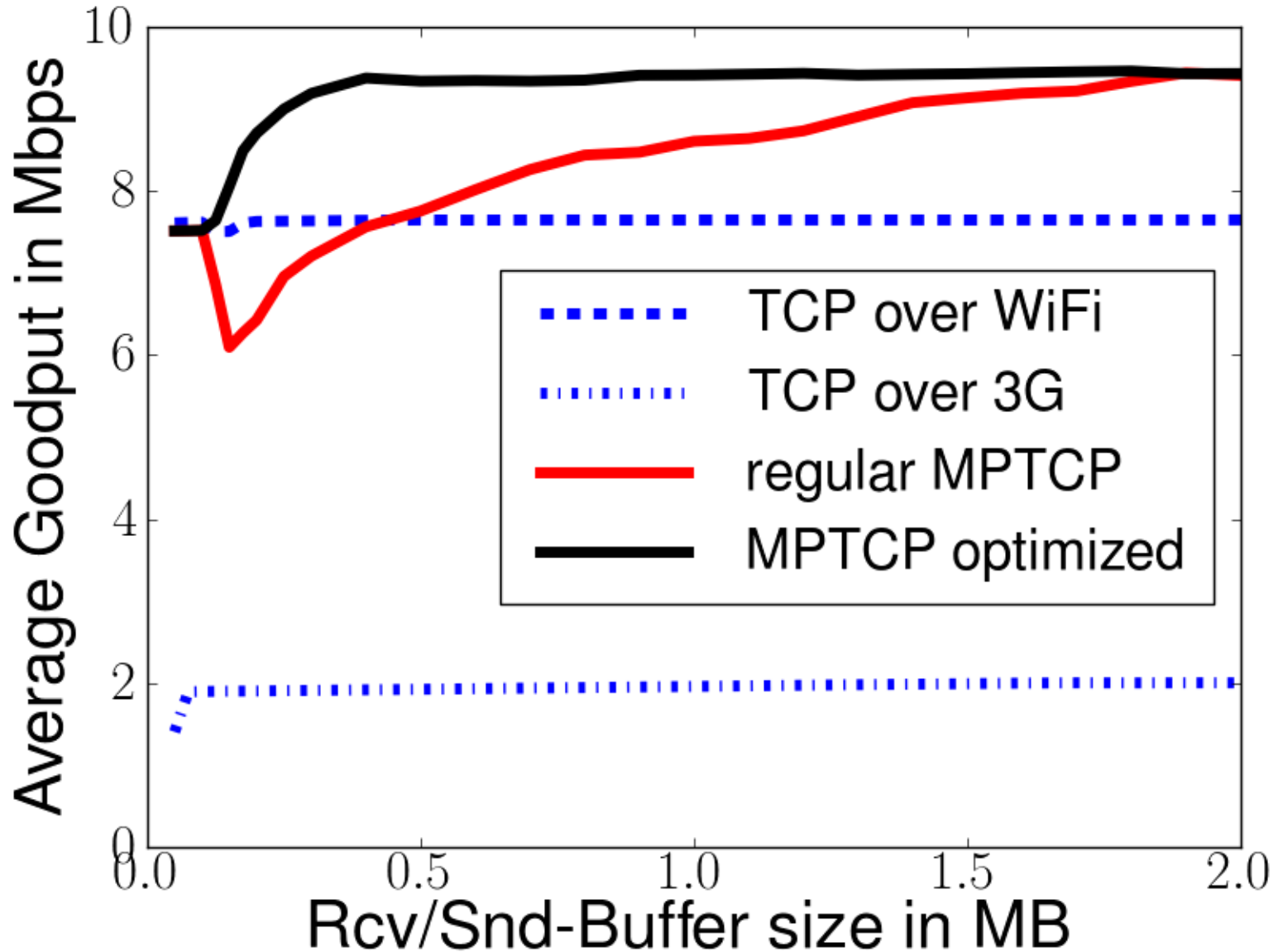

Usage of 3G and WiFi

- How should Multipath TCP use 3G and WiFi ?
 - Full mode
 - Both wireless networks are used at the same time
 - Backup mode
 - Prefer WiFi when available, open subflows on 3G and use them as backup
 - Single path mode
 - Only one path is used at a time, WiFi preferred over 3G

Multipath TCP : Full mode

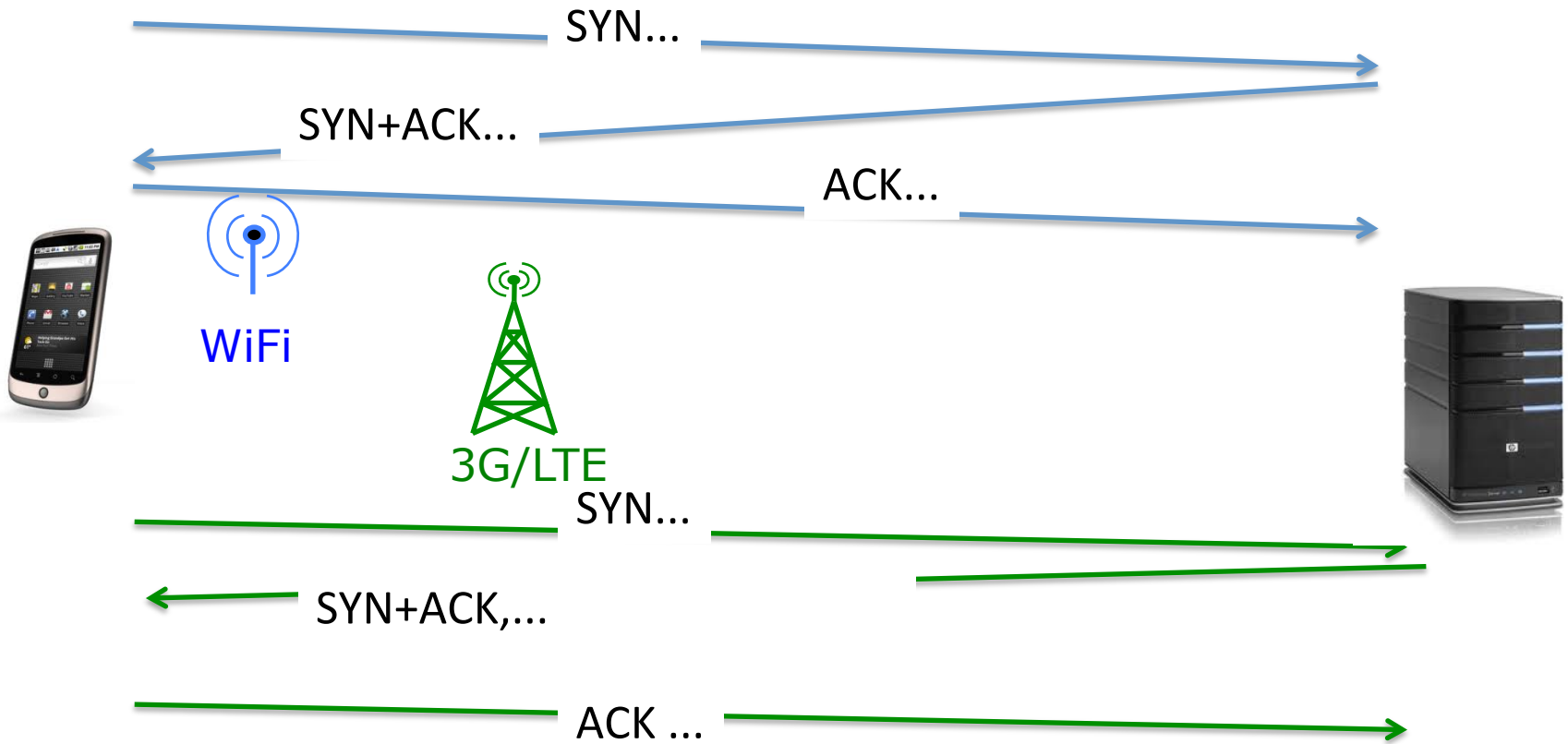

Multipath TCP : Backup mode

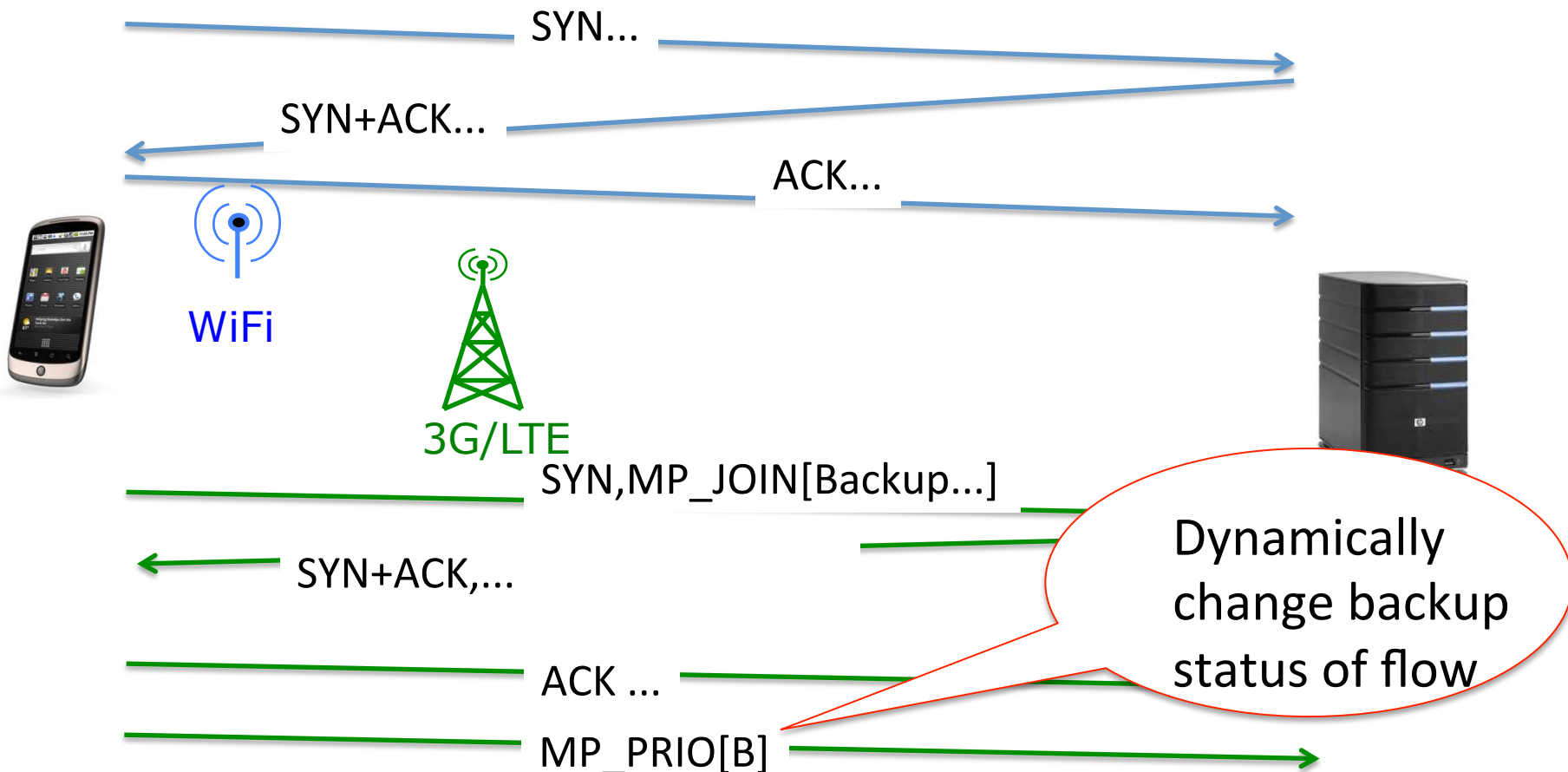

Multipath TCP : Backup mode

- What happens when link fails ?

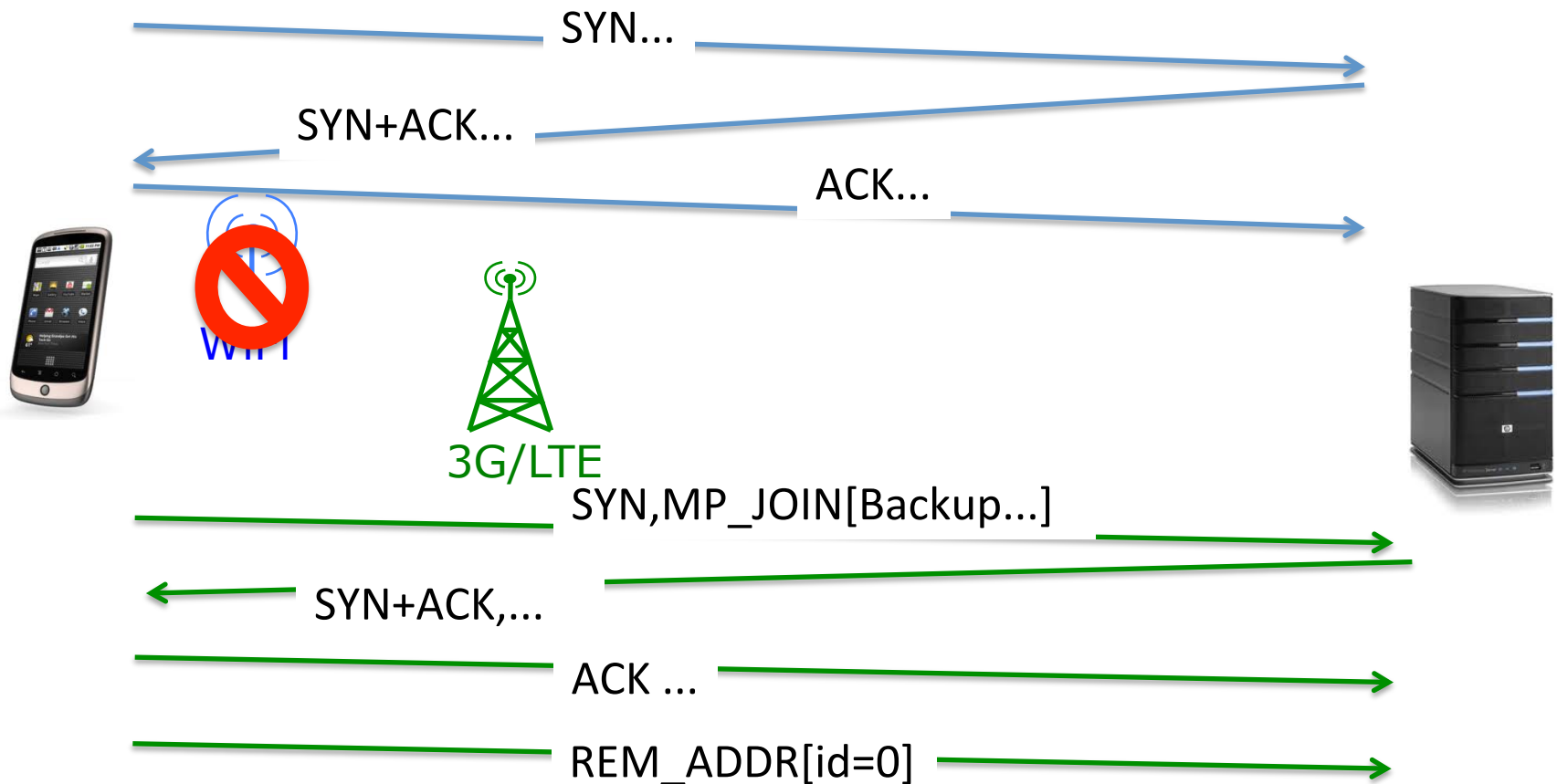

Multipath TCP : single-path mode

- Multipath TCP supports break before make

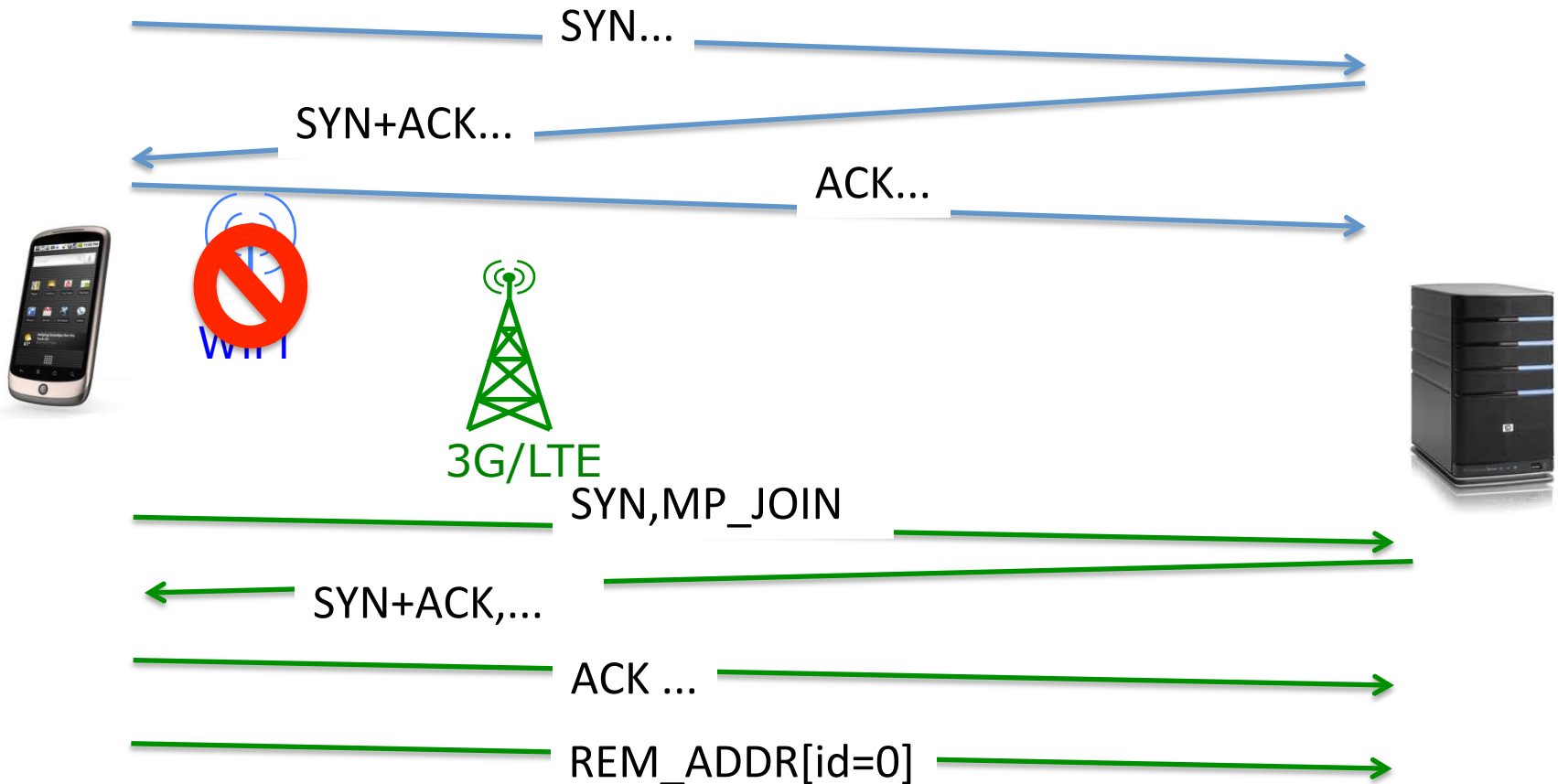

Evaluation scenario

WiFi:
Belgacom ADSL2+
(~8 Mbps, ~30 ms)

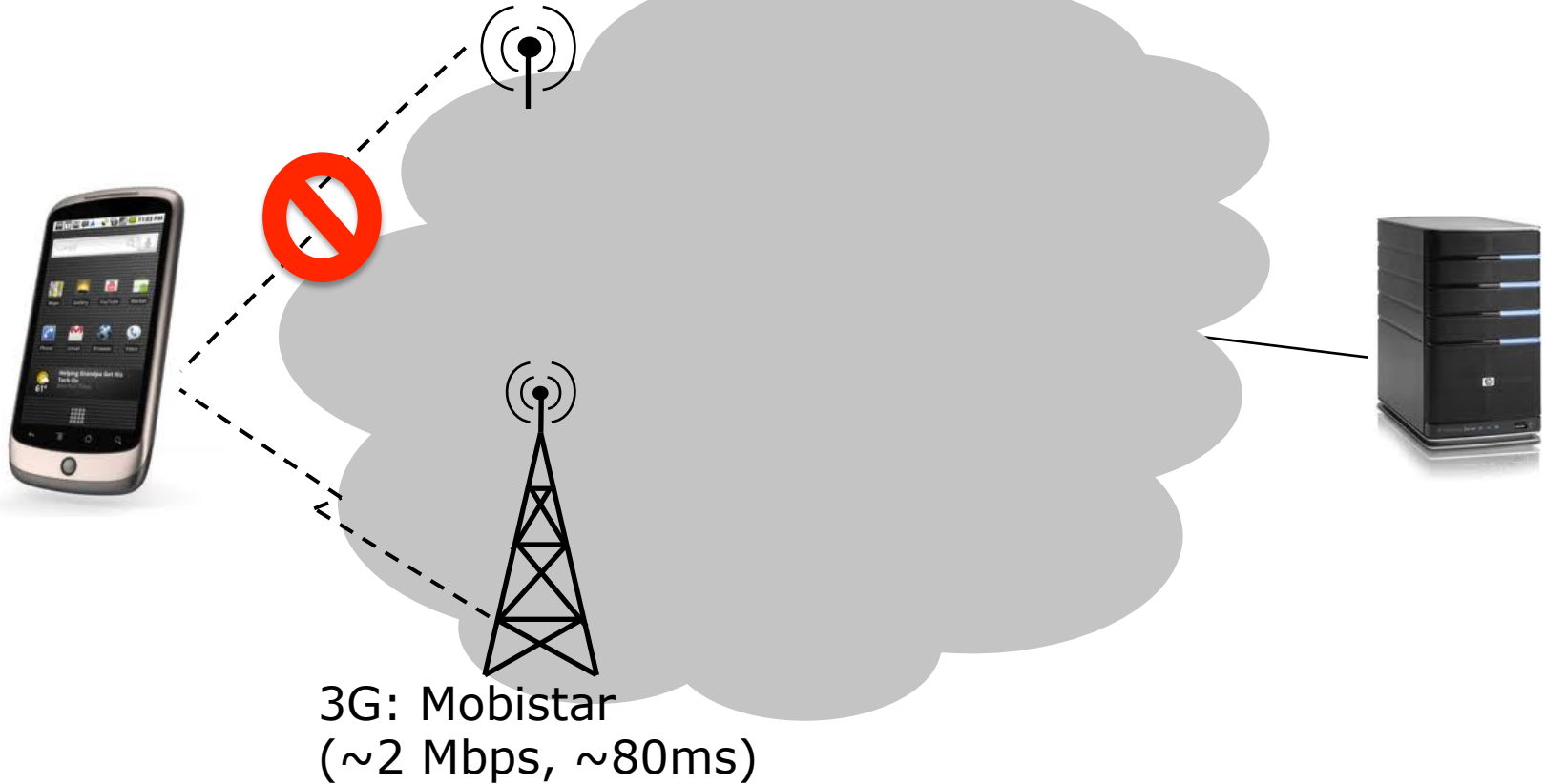

3G: Mobistar
(~2 Mbps, ~80ms)

Recovery after failure

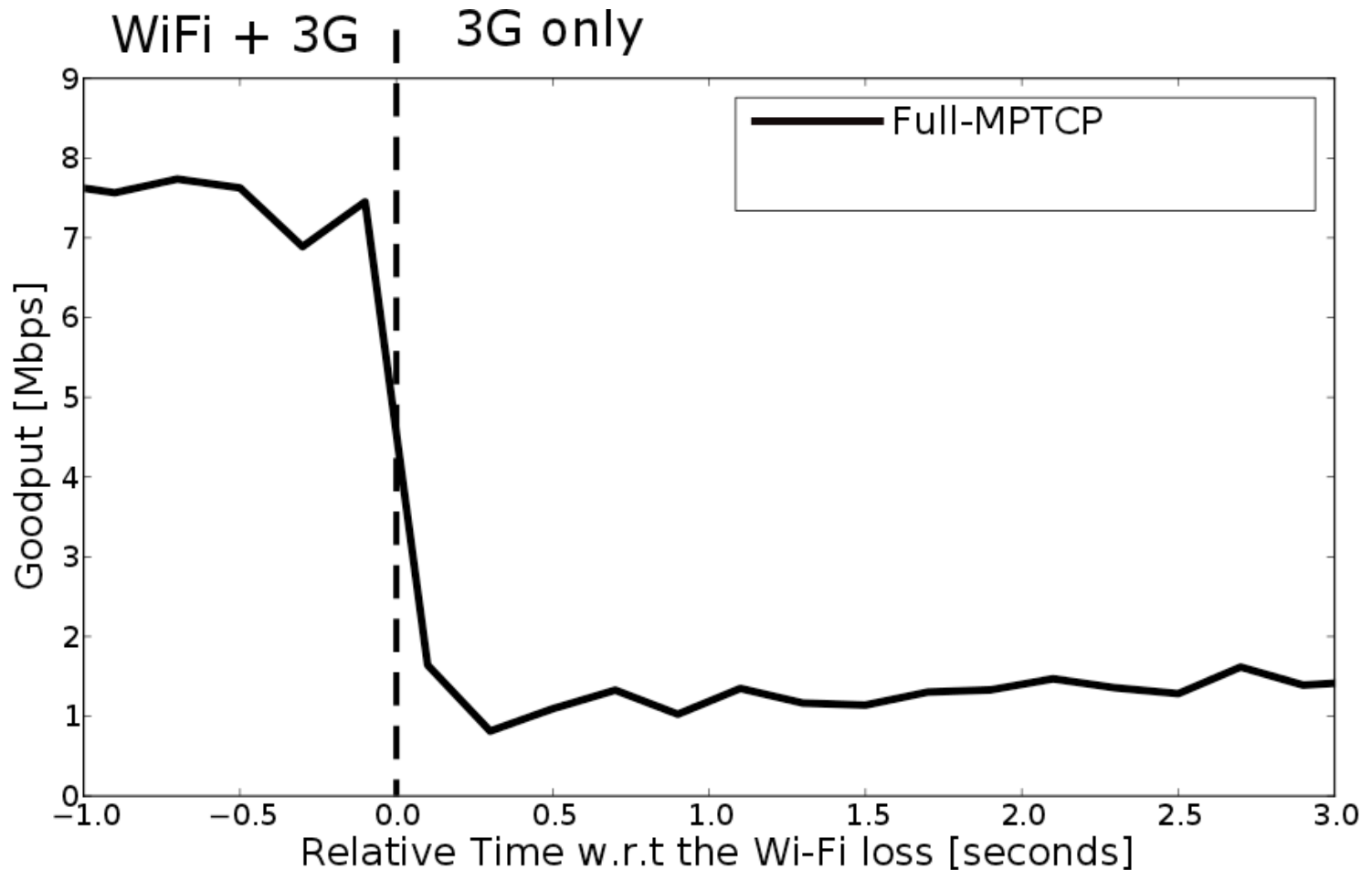

Recovery after failure

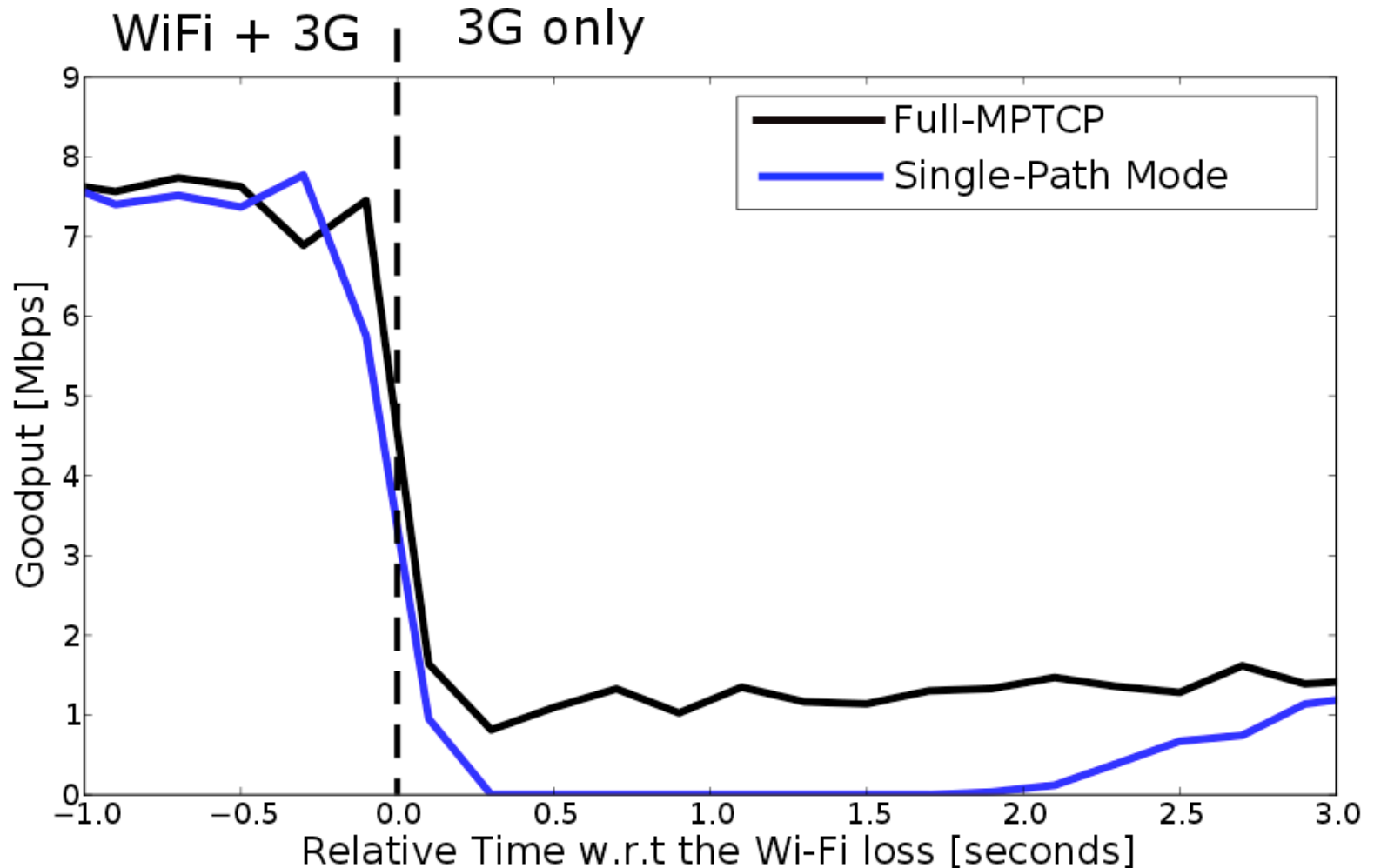

C. Paasch, et al. , "Exploring mobile/WiFi handover with multipath TCP," presented at the CellNet '12: Proceedings of the 2012 ACM SIGCOMM workshop on Cellular networks: operations, challenges, and future design, 2012.

Recovery after failure

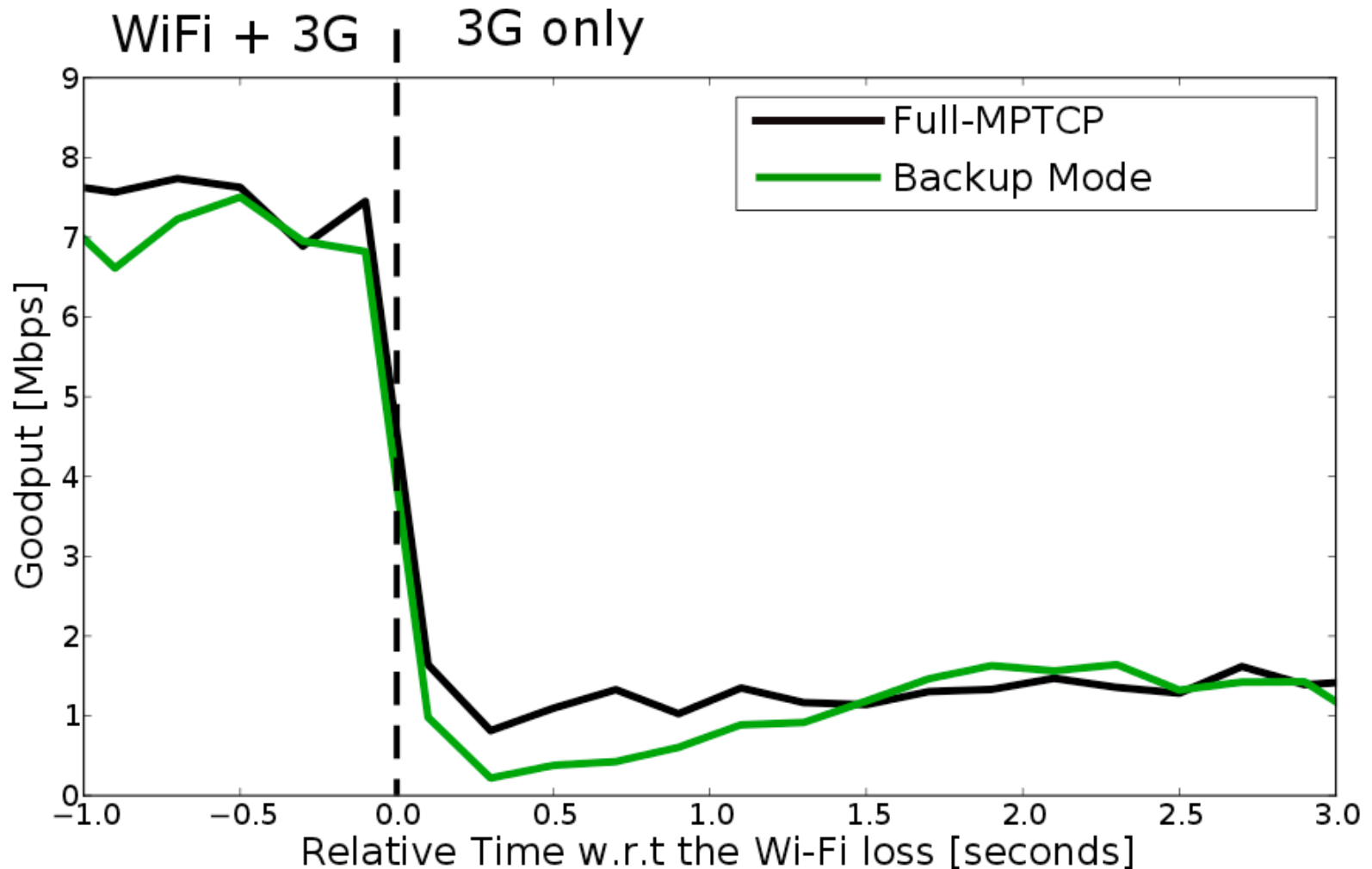

Conclusion

- Multipath TCP is becoming a reality
 - Due to the middleboxes, the protocol is more correct than initially expected
 - RFC will appear and there is running code !
 - Multipath TCP works over today's Internet !
- What's next ?
 - More use cases
 - IPv4/IPv6, anycast, load balancing, deployment
 - Measurements and improvements to the protocol
 - Time to revisit 20+ years of heuristics added to TCP



References

- The Multipath TCP protocol
 - <http://www.multipath-tcp.org>
 - <http://tools.ietf.org/wg/mptcp/>

A. Ford, C. Raiciu, M. Handley, S. Barre, and J. Iyengar, "Architectural guidelines for multipath TCP development", RFC6182 2011.

A. Ford, C. Raiciu, M. J. Handley, and O. Bonaventure, "TCP Extensions for Multipath Operation with Multiple Addresses," Internet draft, draft-ietf-mptcp-multiaddressed-12, 2012

C. Raiciu, C. Paasch, S. Barre, A. Ford, M. Honda, F. Duchene, O. Bonaventure, and M. Handley, "How hard can it be? designing and implementing a deployable multipath TCP," NSDI'12: Proceedings of the 9th USENIX conference on Networked Systems Design and Implementation, 2012.

Implementations

- Linux
 - <http://www.multipath-tcp.org>
 - S. Barre, C. Paasch, and O. Bonaventure, “Multipath tcp: From theory to practice,” *NETWORKING 2011*, 2011.
 - Sébastien Barré. Implementation and assessment of Modern Host-based Multipath Solutions. PhD thesis. UCL, 2011
- FreeBSD
 - <http://caia.swin.edu.au/urp/newtcp/mptcp/>
- Simulators
 - <http://nrg.cs.ucl.ac.uk/mptcp/implementation.html>
 - <http://code.google.com/p/mptcp-ns3/>

Middleboxes

M. Honda, Y. Nishida, C. Raiciu, A. Greenhalgh, M. Handley, and H. Tokuda, “Is it still possible to extend TCP?,” IMC '11: Proceedings of the 2011 ACM SIGCOMM conference on Internet measurement conference, 2011.

V. Sekar, N. Egi, S. Ratnasamy, M. K. Reiter, and G. Shi, “Design and implementation of a consolidated middlebox architecture,” *USENIX NSDI*, 2012.

J. Sherry, S. Hasan, C. Scott, A. Krishnamurthy, S. Ratnasamy, and V. Sekar, “Making middleboxes someone else's problem: network processing as a cloud service,” SIGCOMM '12: Proceedings of the ACM SIGCOMM 2012 conference on Applications, technologies, architectures, and protocols for computer communication, 2012.

Multipath congestion control

– Background

D. Wischik, M. Handley, and M. B. Braun, “The resource pooling principle,” *ACM SIGCOMM Computer ...*, vol. 38, no. 5, 2008.

F. Kelly and T. Voice. Stability of end-to-end algorithms for joint routing and rate control. *ACM SIGCOMM CCR*, 35, 2005.

P. Key, L. Massoulie, and P. D. Towsley, “Path Selection and Multipath Congestion Control,” *INFOCOM 2007*. 2007, pp. 143–151.

– Coupled congestion control

C. Raiciu, M. J. Handley, and D. Wischik, “Coupled Congestion Control for Multipath Transport Protocols,” *RFC*, vol. 6356, Oct. 2011.

D. Wischik, C. Raiciu, A. Greenhalgh, and M. Handley, “Design, implementation and evaluation of congestion control for multipath TCP,” *NSDI'11: Proceedings of the 8th USENIX conference on Networked systems design and implementation*, 2011.

Multipath congestion control

– More

R. Khalili, N. Gast, M. Popovic, U. Upadhyay, J.-Y. Le Boudec, MPTCP is not Pareto-optimal: Performance issues and a possible solution, Proc. ACM Conext 2012

Y. Cao, X. Mingwei, and X. Fu, “Delay-based Congestion Control for Multipath TCP,” ICNP2012, 2012.

T. A. Le, C. S. Hong, and E.-N. Huh, “Coordinated TCP Westwood congestion control for multiple paths over wireless networks,” ICOIN '12: Proceedings of the The International Conference on Information Network 2012, 2012, pp. 92–96.

T. A. Le, H. Rim, and C. S. Hong, “A Multipath Cubic TCP Congestion Control with Multipath Fast Recovery over High Bandwidth-Delay Product Networks,” *IEICE Transactions*, 2012.

T. Dreibholz, M. Becke, J. Pulinthanath, and E. P. Rathgeb, “Applying TCP-Friendly Congestion Control to Concurrent Multipath Transfer,” Advanced Information Networking and Applications (AINA), 2010 24th IEEE International Conference on, 2010, pp. 312–319.

Use cases

– Datacenter

C. Raiciu, S. Barre, C. Pluntke, A. Greenhalgh, D. Wischik, and M. J. Handley, “Improving datacenter performance and robustness with multipath TCP,” *ACM SIGCOMM* 2011.

G. Detal, Ch. Paasch, S. van der Linden, P. Mérindol, G. Avoine, O. Bonaventure, *Revisiting Flow-Based Load Balancing: Stateless Path Selection in Data Center Networks*, to appear in *Computer Networks*

– Mobile

C. Pluntke, L. Eggert, and N. Kiukkonen, “Saving mobile device energy with multipath TCP,” *MobiArch '11: Proceedings of the sixth international workshop on MobiArch*, 2011.

C. Paasch, G. Detal, F. Duchene, C. Raiciu, and O. Bonaventure, “Exploring mobile/WiFi handover with multipath TCP,” *CellNet '12: Proceedings of the 2012 ACM SIGCOMM workshop on Cellular networks: operations, challenges, and future design*, 2012.